

1-Bit PROFESSIONAL MOBILE RECORDER

MR-1000

Owner's Manual

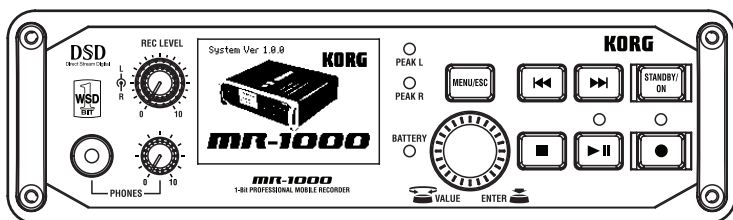

DSD
Direct Stream Digital

KORG

Precautions

Location

Using the unit in the following locations can result in a malfunction.

- In direct sunlight
- Locations of extreme temperature or humidity
- Excessively dusty or dirty locations
- Locations of excessive vibration
- Close to magnetic fields

Power supply

Please connect the designated AC adapter to an AC outlet of the correct voltage. Do not connect it to an AC outlet of voltage other than that for which your unit is intended.

Interference with other electrical devices

Radios and televisions placed nearby may experience reception interference. Operate this unit at a suitable distance from radios and televisions.

Handling

To avoid breakage, do not apply excessive force to the switches or controls.

Care

If the exterior becomes dirty, wipe it with a clean, dry cloth. Do not use liquid cleaners such as benzene or thinner, or cleaning compounds or flammable polishes.

Keep this manual

After reading this manual, please keep it for later reference.

Keeping foreign matter out of your equipment

Never set any container with liquid in it near this equipment. If liquid gets into the equipment, it could cause a breakdown, fire, or electrical shock.

Be careful not to let metal objects get into the equipment. If something does slip into the equipment, unplug the AC adapter from the wall outlet. Then contact your nearest Korg dealer or the store where the equipment was purchased.

THE FCC REGULATION WARNING (for U.S.A.)

This equipment has been tested and found to comply with the limits for a Class B digital device, pursuant to Part 15 of the FCC Rules. These limits are designed to provide reasonable protection against harmful interference in a residential installation. This equipment generates, uses, and can radiate radio frequency energy and, if not installed and used in accordance with the instructions, may cause harmful interference to radio communications. However, there is no guarantee that interference will not occur in a particular installation. If this equipment does cause harmful interference to radio or television reception, which can be determined by turning the equipment off and on, the user is encouraged to try to correct the interference by one or more of the following measures:

- Reorient or relocate the receiving antenna.
- Increase the separation between the equipment and receiver.
- Connect the equipment into an outlet on a circuit different from that to which the receiver is connected.
- Consult the dealer or an experienced radio/TV technician for help.

Unauthorized changes or modification to this system can void the user's authority to operate this equipment.

CE mark for European Harmonized Standards

CE mark which is attached to our company's products of AC mains operated apparatus until December 31, 1996 means it conforms to EMC Directive (89/336/EEC) and CE mark Directive (93/68/EEC).

And, CE mark which is attached after January 1, 1997 means it conforms to EMC Directive (89/336/EEC), CE mark Directive (93/68/EEC) and Low Voltage Directive (73/23/EEC).

Also, CE mark which is attached to our company's products of Battery operated apparatus means it conforms to EMC Directive (89/336/EEC) and CE mark Directive (93/68/EEC).

* Company names, product names, and names of formats etc. are the trademarks or registered trademarks of their respective owners.

Handling of the internal hard disk

Do not apply physical shock to this device. In particular, you must never move this device or apply physical shock while the power is turned on. This can cause part or all of the data on disk to be lost, or may damage the hard disk or interior components.

When this device is moved to a location where the temperature is radically different, water droplets may condense on the hard disk. If the device is used in this condition, it may malfunction, so please allow several hours to pass before operating the device.

Do not turn the power on and off repeatedly. This may damage the MR-1000.

This device begins to access the hard disk immediately after the power is turned on.

Never turn off the power while the HDD access indicator is lit or blinking. Doing so can cause all or part of the data on hard disk to be lost, or may cause malfunctions such as hard disk damage.

If the hard disk has been damaged due to incorrect operation, power failure, or accidental interruption of the power supply, a fee may be charged for replacement even if this device is still within its warranty period.

Data handling

Incorrect operation or malfunction may cause the contents of memory to be lost, so we recommend that you save important data on a CD or other media. Please be aware that Korg will accept no responsibility for any damages which may result from loss of data.

Also, when digitally recording copyrighted audio material from a DAT or CD etc., you must obtain permission for use. Please be aware that Korg will accept no responsibility for any copyright violations which may occur through your use of this product.

COPYRIGHT WARNING

This professional device is intended only for use with works for which you yourself own the copyright, for which you have received permission from the copyright holder to publicly perform, record, broadcast, sell, and duplicate, or in connection with activities which constitute "fair use" under copyright law. If you are not the copyright holder, have not received permission from the copyright holder, or have not engaged in fair use of the works, you may be violating copyright law, and may be liable for damages and penalties. If you are unsure about your rights to a work, please consult a copyright attorney. KORG TAKES NO RESPONSIBILITY FOR ANY INFRINGEMENT COMMITTED THROUGH USE OF KORG PRODUCTS.

Contents

Introduction	6
Features	6
Connection example	6
Parts of the MR-1000	7
Front panel	7
Rear panel	8
Screens and operations	10
Level meter screen and menu list (MENU) screen	10
Selecting parameters and setting values	10
Basic operation	11
1. Power and usage	11
Using the AC adaptor	11
Using the batteries	11
2. Connecting your monitor equipment	13
3. Turning the power on/off	13
Turning the power on	13
Turning the power off	13
4. Playing back the demo project	14
Playing back	14
Pausing	14
Stopping playback	14
Searching for a desired location during playback	14
5. The level meter screen	15
6. Recording	16
Selecting your recording device	16
Selecting the recording format	16
Adjusting the recording level	17
Starting and stopping recording	18
7. Other playback/record operations	19
Selecting and playing back a project/file	19
Using the limiter	20
Using marks within a project	21

8. Other general operations	24
Changing the meter peak hold and the counter mode	24
Editing the project/file name	24
Conserving battery power	26
Setting the date and time	28
Protecting a project	29
Deleting a project/file	29
Viewing details about the project/file	30
Other functions	31
Play mode	31
Play list (PLAY LIST)	33
Creating a play list	33
Viewing a play list	34
Editing a play list	34
Record mode	36
Project recording format (New Project Type)	36
Settings when WAV (BWF) is selected	37
Settings when DFF, DSF, or WSD are selected	37
Recording time for each format (per 1Gbyte)	37
System settings (SYSTEM)	38
LCD Contrast	38
Device information (Device Info)	38
DSD output filter settings (DSD Filter)	39
Formatting the hard disk (HDD Format)	40
Updating the system (Load System)	41
Using the MR-1000 with your computer	42
USB mode	42
Hard disk structure and files	44
Using the AudioGate software	46
Appendix	48
Troubleshooting	48
Various messages	49
Execution messages	49
Error messages	49
Confirmation messages	51
Serious error messages	51
Specifications	52
Index	54

Introduction

Thank you for purchasing the Korg MR-1000 1-bit professional mobile recorder. In order to take full advantage of your new equipment, please read this manual carefully and use the product as directed. When you've read the manual, keep it safe for future reference.

Features

The MR-1000 is an ultra-high-quality recorder that can record and play back in DVD audio format (24-bit/192 kHz), SACD (Super Audio CD) quality format (1-bit/2.8 MHz), and in the even higher-quality 1-bit/5.6 MHz format.

The MR-1000 can operate on batteries, so it is an ideal choice for field recording, and its built-in phantom power supply also allows high-precision condenser mics to be used. An AC adaptor is also included for extended recording sessions or when using the MR-1000 in a fixed location.

The recorded data can be copied to your computer via USB, and data files can be copied from your computer to the MR-1000 for listening.

The MR-1000 includes Korg's "AudioGate" format conversion software, so you can use a computer to convert audio files to different file formats.

Connection example

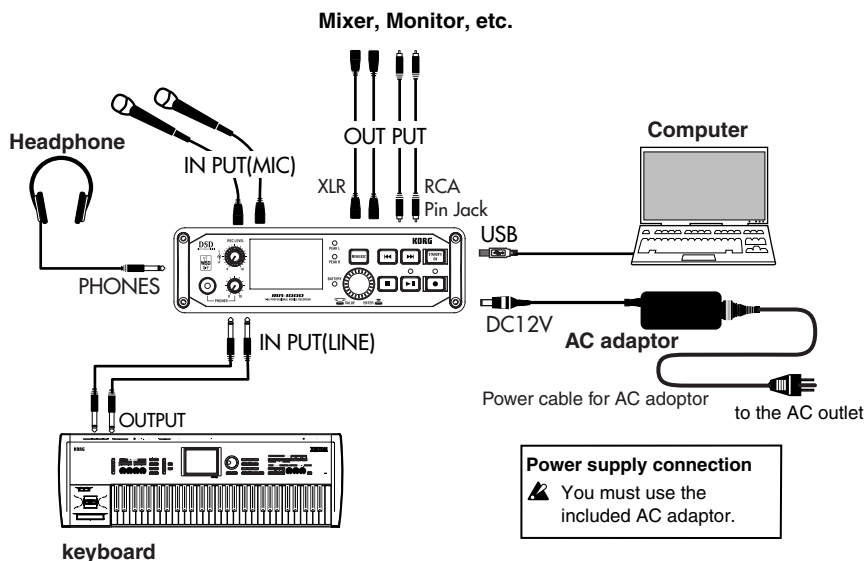

Parts of the MR-1000

Front panel

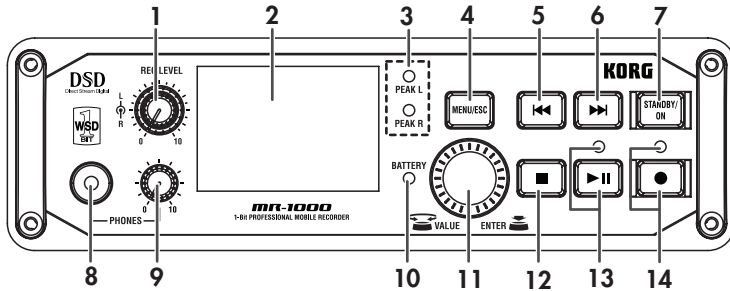

1. Recording level L/R knobs

These adjust the recording level. Set the display to the level meter screen so you can watch the levels, and make adjustments while watching the peak LED (3.). The outside knob adjusts the Left recording level, and the inside knob adjusts the Right recording level.

 *Hum or noise may occur if you raise the recording level when nothing is connected to the input jacks.*

2. Display

The display shows the level meters and counter during recording and playback, and can also show information about the project (→p.14) or file, and parameter settings.

3. Peak LEDs

These will light according to the input level. Adjust the input level so that these do not light red.

4. Menu button

This button accesses the menu list (MENU) screen, allowing you to choose the information or the parameters that will be displayed. Each time you press this, you will alternate between the level meter screen and the menu screen. You can also use this button to return from an editing screen to the previous screen.

5. Rewind button

Use this button to select a project (→p.14) or file, or to rewind.

6. Fast-forward button

Use this button to select a project (→p.14) or file, or to fast-forward.

7. Power button

This turns the MR-1000 on or off (standby).

 *When you turn this off, the shutdown process will occur automatically; do not disconnect the AC adaptor or remove the batteries until the shutdown procedure is complete and the display has gone dark.*

8. Headphone jack

You can connect a set of headphones here.

9. Volume knob

This adjusts the volume of the headphone jack.

10. Battery LED

When operating on batteries, this LED will light red if the remaining battery capacity is low.

11. P-dial

This is a dial with a push-switch function. For more about how to operate it, refer to "Screens and operations" on 10 page.

12. Stop button

This button stops recording or playback.

13. Playback/Pause button, Play LED

This button starts recording or playback. During recording or playback, you can press this button to pause (temporarily halt). This LED will light during playback, and will change to blinking while paused.

14. Record button, Record LED

When you press this button, the MR-1000 will enter record-ready mode (record LED blinking), and recording will begin when you then press the play/pause button (record LED lit). During playback or recording, you can store a Mark (→p.21) by pressing this button. While recording is paused, you can press this button to stop recording.

Rear panel

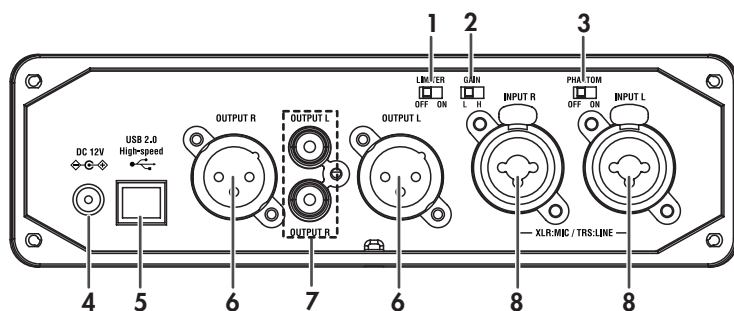

1. Limiter switch

Turn this on if you want to prevent distortion caused by an unexpectedly high input level. The limiter can help prevent input overloads from occurring by limiting the input signal levels. (→p.20).

2. GAIN switch

This switches the input gain between high/low (H/L). Set this to the appropriate position for the input device, in order to achieve the correct recording level.

3. Phantom power switch

This switch provides +48V power to devices such as condenser mics. This power is supplied only to the XLR inputs. Turn this off if you're using dynamic mics or line input sources.

 You can damage your equipment by connecting or disconnecting a condenser mic while the phantom power switch is in the ON position. You must turn the phantom power switch OFF before you connect a condenser mic.

4. DC 12V connector

Connect the included AC adaptor here.

5. USB connector

This lets you use a USB cable to connect the MR-1000 to your computer.

6. Balanced output jacks (XLR)

These are balanced outputs that allow XLR connectors to be used. They output the same audio as the RCA jacks.

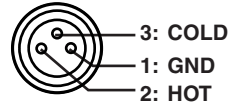

7. Unbalanced output jacks (RCA)

These are unbalanced outputs that allow RCA connectors to be used. They output the same audio as the XLR jacks.

8. Input jacks (XLR/TRS combo)

These are balanced inputs that allow either XLR connectors or TRS phone connectors to be used.

Unbalanced phone plugs can also be connected. Use the XLR jack for mic input, or the TRS phone jack for line input.

 If you're using phantom power with a condenser mic, you must use the XLR jacks.

XLR connector

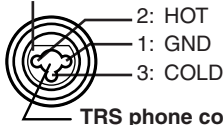

TRS phone connector

TRS phone plug

Balanced

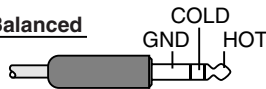

Unbalanced

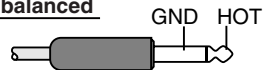

Screens and operations

Level meter screen and menu list (MENU) screen

When you power-on the MR-1000, the display will show the level meter screen.

While the display is showing the level meter screen, pressing the menu button will show the menu list (MENU) screen which lets you proceed to various types of settings or informational screen.

You'll use the P-dial from this screen to make various settings.

When the display shows the menu list (MENU) screen, pressing the menu button will take you back to the level meter screen. In this way, pressing the menu button will alternate between the menu list (MENU) screen and the level meter screen.

When the display shows the level meter screen, pressing the P-dial will show the meter setting screen. Here you can specify what will be shown in the level meter screen. When you've finished making settings, press the menu button to return to the level meter screen.

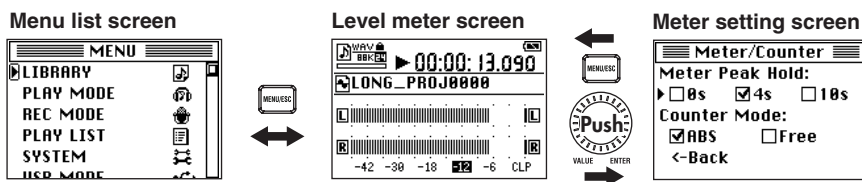

Selecting parameters and setting values

On the MR-1000, you select parameters and set values by turning and pushing the P-dial. The item you've selected by turning the P-dial is shown in the screen by the movement of the selection icon "▢" or "▶".

"▢" indicates that an additional setting screen will appear when you press the P-dial.

To select parameters and set values, you will turn the P-dial to move this selection icon or modify the value, and then press the P-dial to confirm the modified value. On the MR-1000, we'll tell you to "use the P-dial to select and confirm" the item you're setting.



Depending on the parameter, selecting and confirming an item may cause a further setting screen to appear, or may cause a check mark to appear in a check box.

If you've made a setting in a further setting screen, you can press the menu button to return to the previous screen.

Basic operation

1. Power and usage

If you're using the MR-1000 in a location where AC power is available, use the included AC adaptor. If you're using it while moving or for outdoor recording, you can use separately sold alkaline batteries (LR6), Oxyride batteries, or nickel metal-hydride batteries.

note *Nickel metal-hydride batteries are normally uncharged when you purchase them. You will need to recharge them before use. Rechargeable batteries that have been newly purchased or stored for an extended period of time may not be capable of reaching a full charge. You may need to charge and discharge them several times before use. For details, refer to the manual that came with your batteries or charger.*

Using the AC adaptor

Plug the power cable of the included AC adaptor into an AC outlet. Connect the DC plug of the AC adaptor to the DC 12V connector on the back of the MR-1000.

Using the batteries

Open the battery compartment lid on the top, and install eight AA alkaline batteries (LR6), Oxyride batteries, or charged nickel metal-hydride batteries, making sure to observe the correct polarity of each battery. When you've installed the batteries, replace the lid of the battery compartment.

! *When you replace the batteries, don't mix batteries from different manufacturers or different types of battery, nor should you mix new batteries with used batteries. Doing so may cause the batteries to burst or ignite.*

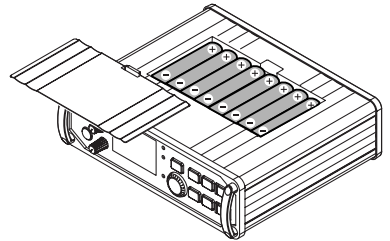

Types of usable batteries and their lifespan

(for 16-bit/44.1 kHz or DSDIFF, 2.8 MHz operation)

Battery type	Continuous recording time / Continuous playback time (backlight off, temperature 20°C, humidity 50%)
Eight AA alkaline batteries	4/4 hours
Eight AA Oxyride batteries	4/4 hours
Eight AA nickel metal-hydride batteries	4/4 hours

Battery remaining indication

The battery icon in the level meter screen shows an approximate indication of the amount of power remaining in the batteries. If you continue playing or recording when the battery low indication is shown, and the batteries are exhausted, the shutdown screen will appear automatically and the power will turn off several seconds later.

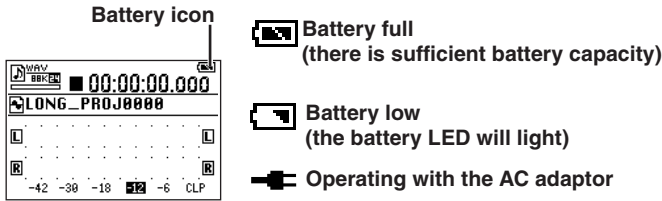

note If you're using the AC adaptor, the battery icon will change to a plug icon.

- !** If you're using AA alkaline batteries (LR6), the battery life may be shorter depending on the quality of the batteries or the length of time since their date of manufacture. Due to their inherent character, alkaline batteries will provide a much shorter running life in extremely cold temperatures.
- !** If you're using nickel metal-hydride batteries, certain types of battery or certain conditions of the batteries may cause the battery low indication to appear after a short time, or the unit to shut down immediately after the battery low indication appears. Please understand the characteristics of the batteries you're using.

2. Connecting your monitor equipment

Connect stereo headphones to the headphone jack.

Connect your monitor system to the output jacks. You can use either the XLR or RCA jacks. Use the volume knob to adjust the volume.

 *Connecting headphones will not cut the sound from the output jacks.*

 *If you're recording from mics, you should use headphones to reduce the possibility of acoustic feedback.*

3. Turning the power on/off

The MR-1000 contains an internal hard drive, and is a precision device comparable to a computer.

You must observe the following procedure when turning the MR-1000 on or off.

Turning the power on

Press the power button. The opening screen will appear, and then the level meter screen will appear.

If you're using batteries and the power does not turn on, there is insufficient battery capacity remaining. Please install new batteries.



Turning the power off

Hold down the power button for two seconds or longer. The shutdown screen will appear, and the power will turn off automatically a few seconds later.

 *If you disconnect the AC adaptor or remove the batteries before the power turns off, you may damage the project/file or the MR-1000's internal circuitry*

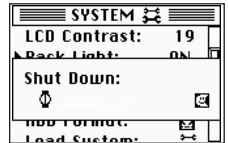

Make sure that the screen is dark (power off) before you disconnect the AC adaptor or remove the batteries.

Auto shutdown function

If the MR-1000 is operating on its battery, and a certain length of time elapses after you've stopped the recorder and not performed any further operations, the shutdown screen will appear automatically and then the power will turn off (→p.27).

4. Playing back the demo project

The MR-1000 contains a high-quality demo project that was recorded in DFF(DSDIFF) format. Here's how to play back this project.

What is a project?

When you record on the MR-1000, two files are created; an audio file and a project file (containing protection data and markers, etc.). These two files are collectively called a "project," and can be operated on the MR-1000 as if they were a single audio file. (→p.44 "Hard disk structure and files")

Playing back

When you've turned on the power, make sure that the demo project name is shown in the upper part of the level meter screen, and press the play/pause button. The demo project recorded on the MR-1000 will play back.

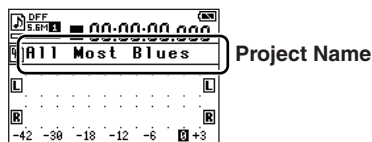

note If something other than the demo project is shown, select the demo file as described in "Selecting and playing back a project/file" (p.19).

Pausing

During playback, press the play/pause button to pause at that location. When you press the play/pause button once again, playback will resume from that location.

Stopping playback

During playback, press the stop button.

If you then press the play/pause button, playback will start from the beginning of the currently selected project/file.

Searching for a desired location during playback

During playback, you can hold down the rewind button to rewind while listening to the sound. You can hold down the fast-forward button to fast-forward while listening to the sound.

note If you assign marks to a project, you'll be able to move quickly to a desired point (→p.21).

5. The level meter screen

When you turn on the power, the level meter screen is shown in the display. When the menu list (MENU) screen is shown, you can also access the level meter screen by pressing the menu button.

This screen shows information such as the MR-1000's operating status and recording/playback format.

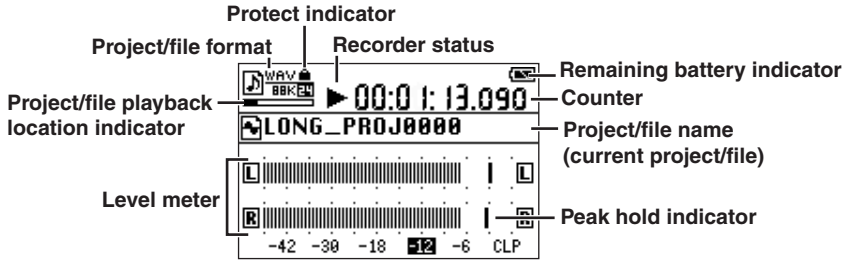

Protect indicator

A lock symbol is shown if the current project is protected. Nothing is shown if the protect setting is off (→p.29).

Project/file format

This shows the format of the current project/file (→p.36).

Recorder status

The current status of the recorder is shown using symbols such as record (●), play (▶), or stop (■).

Remaining battery indicator

This icon shows the amount of battery charge remaining.

Project/file playback location indicator

This is a graphical indication of the approximate position of the current counter value compared to the overall length of the current project/file.

Level meter

This shows the audio input level or monitor level.

Counter

The counter shows either the current location (as elapsed time since the beginning of the recording), or the remaining amount of time that can be recorded (→p.24).

Project/file name (current project/file)

This shows the name of the currently selected project/file.

Peak hold indicator

When you're adjusting the audio input level or monitor level, it may be helpful to lengthen the "Meter Peak Hold" setting in the Meter/Counter screen (→p.24).

6. Recording

When you record on the MR-1000, date and time information is automatically added to the file so that you can manage your projects more easily.

note *If you set the MR-1000's date and time (→p.28), the correct date and time data will be added. However, if the batteries do not have enough power to turn the MR-1000 on and you let it sit for a few days (or if the AC adaptor is not connected), the date and time will be reset. After changing the batteries or connecting the MR-1000 to the AC adaptor, please make these settings once again.*

Selecting your recording device

You can record into the MR-1000 not only from devices with a high output level such as a keyboard or audio device, but also from low output level devices such as microphones.

Recording using the line inputs

If you're recording from a device whose line output level is low (consumer level), set the GAIN switch to high (H). If you're recording from a device whose line output level is high (professional), set the GAIN switch to low (L).

You can use balanced or unbalanced 1/4" TRS phone jacks to make connections.

note *If the level is too low even when the input level L/R knob is turned up, set the GAIN switch to the H position.*

Recording using the mic inputs

Use the XLR connectors to make connections.

If you need phantom power for your condenser mic, set the phantom power switch (48V) located on the back panel to the ON position.

 *Make sure that your mic is already connected before you turn the phantom power on.*

Selecting the recording format

Here's how to select the recording format. Each time you record, a new project will be created in the recording format you've selected.

note *The default setting is DFF, 5.6 MHz.*

1. Press the menu button, and in the menu list, use the P-dial to select and confirm "REC MODE." The record mode (REC MODE) setting screen will appear.

Selection icon



Recording mode screen



2. Use the P-dial to select and confirm the Project Type.

A check mark will appear in the check box for the project type you selected and confirmed. You can choose from WAV (BWF), DFF, DSF, and WSD. For details on each type, refer to "Project recording format" (p.36).

If you've selected WAV

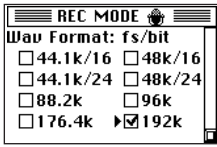

OR

If you've selected DFF, WSD, DSF

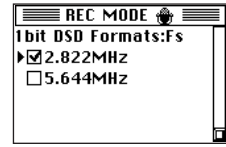
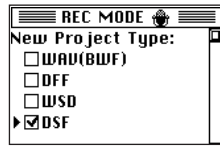

3. If you checked WAV (BWF), use the P-dial to select and confirm the desired Wav Format: fs/bit setting (bit depth and sampling frequency).

If you check DFF, DSF, or WSD, use the P-dial to select and confirm the sampling frequency in the 1bit DSD Format:Fs setting.

4. When you've finished setting the recording mode, press the menu button to return to the menu list screen, and then press the menu button once again to return to the level meter screen.

Adjusting the recording level

Here's how to adjust the recording level.

1. Press the record button to enter record-ready mode.

The record LED will blink.

2. While watching the level meter screen, use the recording level L and R knobs to set the level as high as possible without allowing the signal to clip when the volume is loudest.

Adjust the level so that the signal does not exceed the "0" marking.

If clipping occurs, the peak LED will light red.

note If you want to prevent clipping caused by unexpected high levels, turn the back panel limiter switch ON (→p.20).

Starting and stopping recording

Each time you record on the MR-1000, a folder is created containing an audio file and a settings file, collectively called a "project." The folder is named automatically (→p.45).

You can edit this name after you've finished recording (→p.24).

Operations on the MR-1000 will handle the entire project folder just as if it were an audio file.

- 1. To start recording from the record-ready mode, press the play/pause button (the play LED will light).**

The record LED will change from blinking to lit.

- 2. To pause recording, press the play/pause button (the play LED will blink); to resume recording, press the play/pause button once again (the play LED will light).**

A new project is not created if you pause during recording; the recording will still be a single project.

- 3. When you're finished recording, press the stop button.**

The record LED and play LED will go dark.

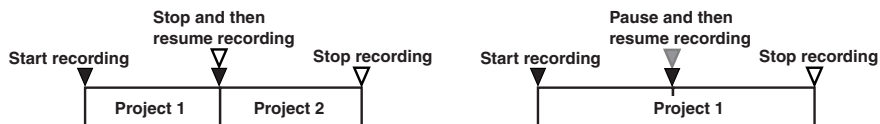

7. Other playback/record operations

Selecting and playing back a project/file

You can use the rewind and fast-forward buttons or the P-dial to select the project/file that you want to play. However if the playback mode (→p.31) is set to "Current Proj/File", you can not use the rewind/fast-forward buttons to select the project/file.

note When you turn on the power, the most recently selected project/file will be selected.

Selecting a project/file using the rewind & fast-forward buttons

During playback or while stopped, you can press the rewind button to select the project/file that precedes the currently selected one, or the fast-forward button to select the next project/file.

Selecting a project/file using the P-dial

1. Press the menu button, and in the menu (MENU) screen, use the P-dial to select and confirm "LIBRARY."

The library select (LIBRARY) screen will appear.

2. The selection icon is shown at "Current Proj/File." If you want to select a project/file other than the currently selected project/file, use the P-dial to select and confirm one of the other folders.

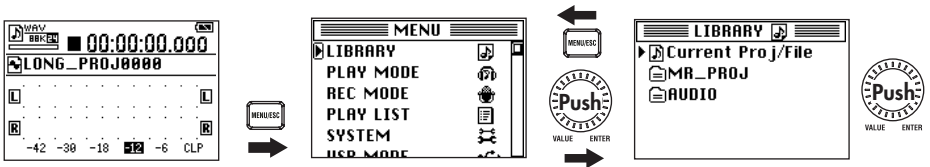

Inside the "MR_PROJ" folder are other folders that organize the files recorded on the MR-1000 by their format. Select and confirm a folder to choose a project inside that folder.

The "AUDIO" folder contains audio files that were created on a device other than the MR-1000.

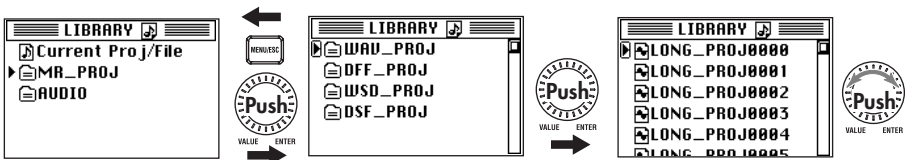

3. The selection icon is shown at the currently selected project/file. Use the P-dial to select and confirm the desired project/file.

The display will show the editing screen for the current file.

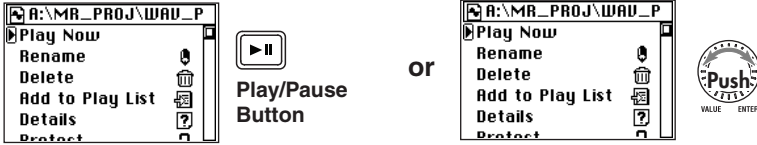

4. Press the play button to begin playing the selected project/file.

Alternatively, you can begin playback by using the P-dial to select and confirm "Play Now" in the file edit screen.

Using the limiter

If you want to prevent clipping that might be caused by sudden high levels, turn on the limiter switch located on the back panel.

When this switch is on, the peak levels will be lowered by up to 6 dB, but the dynamic range will feel narrower.

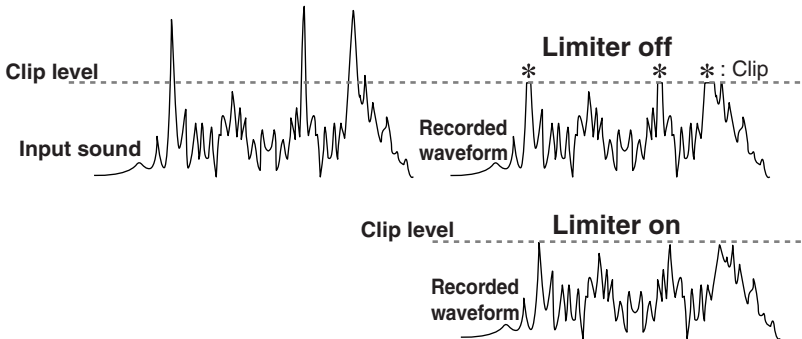

Using marks within a project

If you've made an extended recording, such as of a live performance or a practice session, you can move between songs or to a desired location by moving while you listen to the sound or by fast-forwarding or rewinding according to the counter time.

However, the MR-1000 also lets you add marks to a project during recording or playback, and use the rewind and fast-forward buttons to rapidly move between these marks during playback.

Adding a mark

To add a mark, simply press the record button during recording or playback. You can add up to 100 marks, and edit them later.

 *Markers are automatically added at the beginning of the project, and at locations at which you resume recording after you pause recording.*

 *You can only add marks to a project that was recorded on the MR-1000.*

Viewing the mark list

Here's how to view a list showing the marks in a project in the order of their time location.

1. Press the menu button, and in the menu list (MENU) screen, use the P-dial to select and confirm "LIBRARY."

The library select (LIBRARY) screen will appear.

2. Use the P-dial to select and confirm the project whose mark list you want to see. (Refer to "Selecting and playing back a project/file," p.19)

The project/file edit screen will appear.

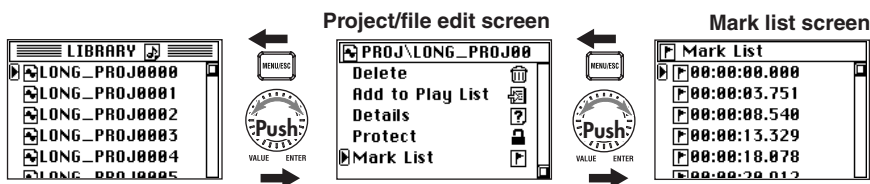

3. In the project/file edit screen, use the P-dial to select and confirm "Mark List."

The mark list (Mark List) screen will appear.

Using marks to move

1. Press the menu button, and in the menu list (MENU) screen, use the P-dial to select and confirm "PLAY MODE."

The playback mode select (PLAY MODE) screen will appear.

2. Use the P-dial to select and confirm "Current Proj/File" as the playback mode.

3. Press the menu button, and in the menu list (MENU) screen, use the P-dial to select and confirm "LIBRARY."

The library select (LIBRARY) screen will appear.

4. Select and confirm a project that contains marks.

Now you can move to the locations where you added the marks.

Regardless of the screen shown in the display, you can press the rewind or fast-forward button during playback to move to the time location of the previous or next mark.

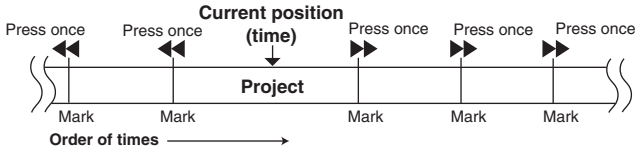

If you've selected something other than "Current Proj/File" (→p.31) as the play mode (play Current Folder, PlayList, Shuffle, etc.), you can't use the rewind or fast-forward buttons to move between marks.

Editing marks

You can edit the time locations of the marks shown in the mark list (Mark List) screen, or delete unwanted marks.

 You can edit the marks even of a project whose Protect setting is on, but they will revert to their unedited state when you select a different project or turn off the power.

1. In the mark list (Mark List) screen, use the P-dial to select and confirm the mark that you want to edit.

The mark edit select (Mark Edit) screen will appear.

To return to the mark list (Mark List) screen, press the menu button (or use the P-dial to select and confirm "<- Back" in the screen).

2. Use the P-dial to select and confirm the item you want to edit.

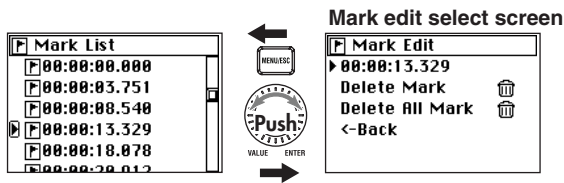

Editing the time location of a mark

1. When you use the P-dial to select and confirm the time location of a mark, you'll be able to edit it.

The selection icon will change from "▶" to "▷".

2. The highlighted place will change each time you press the P-dial.

By pressing the P-dial when the last place is highlighted, you can exit from editing the time location; to continue editing the time location, simply press the P-dial once again.

3. To change the digits of the highlighted place, turn the P-dial to specify the value and press the P-dial to confirm it.

Repeat these steps to specify the time location for the mark.

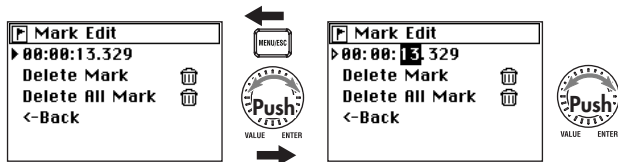

When you've finished making settings, press the P-dial several times to return to the Mark Edit screen.

Deleting a mark (Delete Mark)

1. When you use the P-dial to select and confirm "Delete Mark," a dialog screen will ask you to confirm the deletion.
2. Use the P-dial to select and confirm [Yes].
If you decide not to delete the mark, use the P-dial to select and confirm [No] (or press the menu button), and you'll return to the mark edit select (Mark Edit) screen.
3. The screen will indicate "Working..." and the mark will be deleted. When deletion is finished, the screen will indicate "Complete."
4. Press the P-dial (or the menu button) to return to the mark list (Mark List) screen.

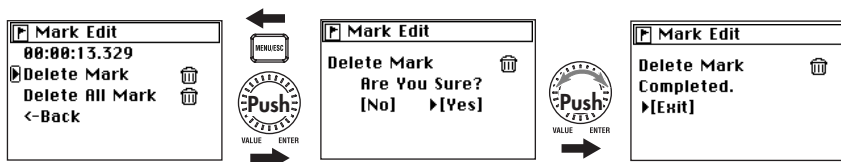

Deleting all marks (Delete All Mark)

1. When you use the P-dial to select and confirm "Delete All Mark," a dialog screen will ask you to confirm the deletion.
2. Use the P-dial to select and confirm [Yes].
If you decide not to delete the marks, use the P-dial to select and confirm [No] (or press the menu button), and you'll return to the mark edit select (Mark Edit) screen.
3. The screen will indicate "Working..." and the marks will be deleted. When deletion is finished, the display will indicate "Complete."
4. Press the P-dial (or the menu button) to return to the mark list (Mark List) screen.

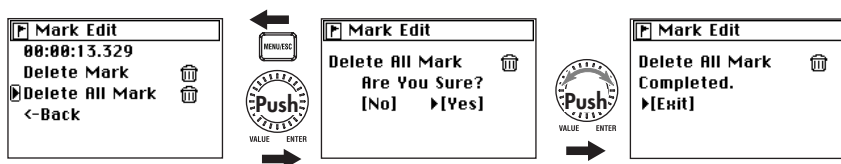

5. Verify that all marks have been deleted, and press the menu button to return to the project/file edit screen.

8. Other general operations

Changing the meter peak hold and the counter mode

1. From the level meter screen, press the P-dial.

The meter/counter (Meter/Counter) screen will appear.

2. Use the P-dial to select and confirm "Meter Peak Hold" (peak indicator hold time).

A check mark will appear in the hold time check box you selected (0 seconds, 4 seconds, 10 seconds).

3. Use the P-dial to select and confirm "Counter Mode" (counter display mode).

A check mark will appear in the mode check box you selected.

ABS: The location is shown as an absolute time, with 0 (zero) as the point at which recording began for the file.

Free: The remaining recordable time is displayed, as calculated from the current file format (→p.38) and the amount of space remaining on the hard disk.

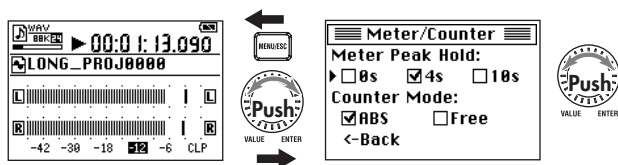

4. When you've finished making settings, press the menu button to return to the level meter screen.

You can also confirm and return by using the P-dial to select and confirm "<-Back" in the screen.

Editing the project/file name

You can specify a name of up to sixteen characters, using uppercase alphabetical characters A-Z, lowercase alphabetical characters a-z, numerals 0-9, and the following symbols.

! # \$ % & ' () + , - ; = [] ^ _ ` { } ~

 You can't edit the name of a project that's protected.

1. Press the menu button, and in the menu list (MENU) screen, use the P-dial to select and confirm "LIBRARY."

The library select (LIBRARY) screen will appear.

- Use the P-dial to select and confirm the project/file whose name you want to edit. (See "Selecting and playing back a project/file," p.19)

If you want to edit the name of the currently selected project/file, simply press the P-dial twice to confirm.

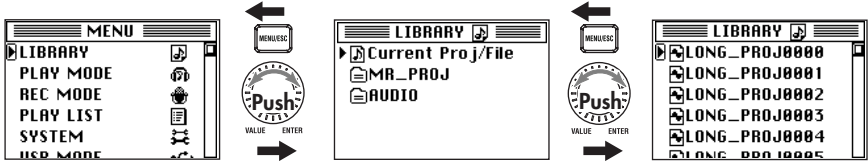

- The project/file edit screen will appear, with the currently selected project/file name shown at the top.

- Use the P-dial to select and confirm "Rename."

The name editing screen will appear.

Project/file edit screen

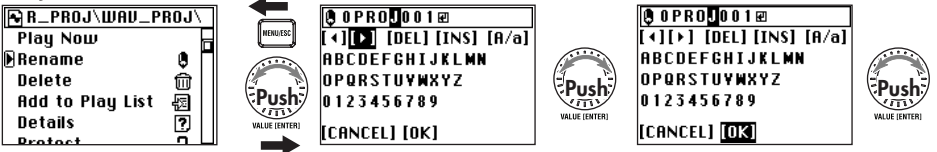

- Use [◀] or [▶] to move to the position of the character you want to edit (highlighted), and use the P-dial to confirm.

- The character will be selected and highlighted. Use the P-dial to select and confirm the desired character.

[DEL]----- Deletes the currently highlighted character and moves the subsequent characters toward the left.

[INS]----- Inserts a space at the highlighted location.

[A/a]----- Switches between uppercase letters, lowercase letters, and symbols.

Repeat these steps to edit the name.

- When you've finished editing the name, use the P-dial to select (highlight) and confirm [OK]. You will return to the file edit select screen.

If you use the P-dial to select (highlight) and confirm [Cancel], the changes you made will be discarded when you return to the project/file edit select screen.

Conserving battery power

If you're using with the MR-1000 operating on battery power, you can reduce power consumption by turning off unneeded circuitry.

Backlight setting

You can turn the backlight off if you're using the MR-1000 in a brightly lit location, or make it automatically turn off a set period of time after the most recent operation.

1. **Press the menu button, and in the menu list (MENU) screen, use the P-dial to select and confirm "SYSTEM."**

The system setting (SYSTEM) screen will appear.

2. **Use the P-dial to select and confirm "Back Light."**

The selection icon will change from "▶" to "▷", and the value will be highlighted.

3. **Turn the P-dial to specify the amount of time until the backlight will turn off.**

If this is "OFF," the backlight will not turn on. If this is "ON," the backlight will always remain on.

To turn the backlight on, select "ON" in the same way.



4. **Press the P-dial (or the menu button) to complete the backlight setting.**

The selection icon will change from "▶" to "▷". Alternatively, you can press the P-dial to complete the setting.

Auto shutdown setting

If no operations have been performed for the length of time you specify here, the shutdown screen will appear automatically, and the power will turn off several seconds after that. This will prevent the battery from running down in the event you forget to turn off the power.

1. Press the menu button, and in the menu list (MENU) screen, use the P-dial to select and confirm "SYSTEM."

The system setting (SYSTEM) screen will appear.

2. Use the P-dial to select and confirm "AutoShutDown."

The selection icon will change from "▶" to "▷", and the setting will be highlighted.

3. Turn the P-dial to specify the time until when the power will turn off.

If this is set "OFF" the power will stay on; Auto shutdown will not occur.

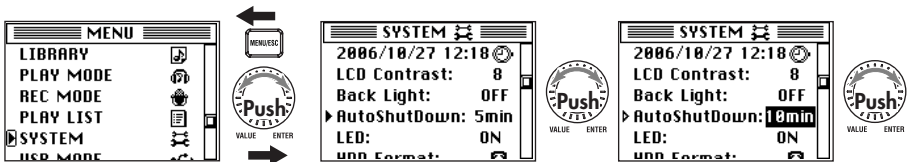

4. Press the P-dial (or the menu button) to complete the Auto shutdown setting.

The selection icon will change from "▷" to "▶".

LED setting

Normally, the recording LED will light while recording, but you can reduce the power consumption even further by turning this LED function off.

1. Press the menu button, and in the menu list (MENU) screen, use the P-dial to select and confirm "SYSTEM."

The system setting (SYSTEM) screen will appear.

2. Use the P-dial to select "LED."

The selection icon will change from "▶" to "▷", and the setting will be highlighted.

3. Turn the P-dial to select "OFF."

To turn the LED back on again, perform the same operation to select "ON."

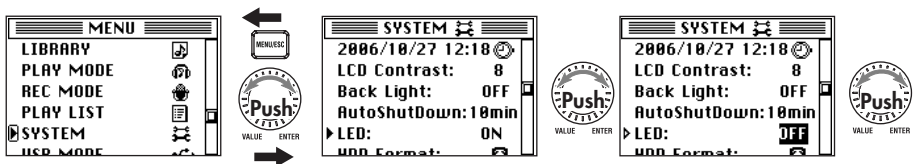

4. Press the P-dial (or the menu button) to complete the LED setting.

The selection icon will change from "▷" to "▶".

Setting the date and time

If you set the MR-1000's date and time, the recorded files will have the correct date and time stamp. Here's how to set the internal clock.

1. Press the menu button, and in the menu list (MENU) screen, use the P-dial to select and confirm "SYSTEM."

The system setting (SYSTEM) screen will appear.

2. Use the P-dial to select and confirm the date and time indication in the top line.

The date and time setting (Clock) screen will appear.

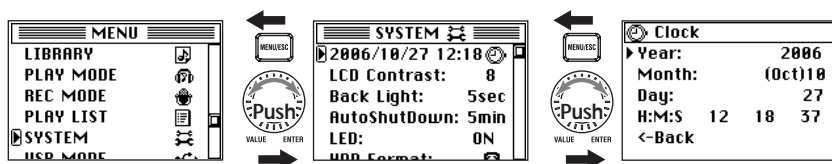

3. Use the P-dial to select and confirm "Year."

The selection icon will change from "▶" to "▷", and the year indication will be highlighted.

4. Turn the P-dial to select the year, and press the P-dial (or the menu button) to confirm.

The selection icon will change from "▷" to "▶".

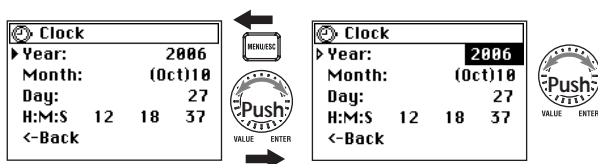

5. In the same way, use the P-dial to select and confirm the "Month," "Day," "Hour," "Minute," and "Sec."

6. When you've finished making settings, press the menu button to return to the system setting (SYSTEM) screen.

Alternatively, you can return by using the P-dial to select and confirm "<-Back" in the screen.

⚠ If you disconnect the AC adaptor or leave the batteries out for about a week, the date and time settings will be reset, so you will have to install batteries or connect the AC adaptor and make these settings again. If the date and time have been reset, a message to remind you of this will be displayed.

⚠ The time will continue to advance while you're setting it.

Protecting a project

Here's how to protect a project. If you edit the name or delete or edit the mark settings of a project that is protected, these settings will revert to their original state when you select another project or turn off the power. A protected project is indicated by a lock icon displayed in the project/file information field (the top line) of the level meter screen.

note You can't protect an audio file that was recorded by a device other than the MR-1000 (such files will be located in the AUDIO folder).

1. Press the menu button, and in the menu list (MENU) screen, use the P-dial to select and confirm "LIBRARY."

The library select (LIBRARY) screen will appear.

2. Use the P-dial to select and confirm the project whose Protect setting you want to change. (See "Selecting and playing back a project/file," p.19)

If you want to protect the currently selected project, simply press the P-dial twice to confirm.

3. The project/file edit screen will appear, with the name of the project you just selected shown at the top.

4. Turn the P-dial to move the selection icon to "Protect."

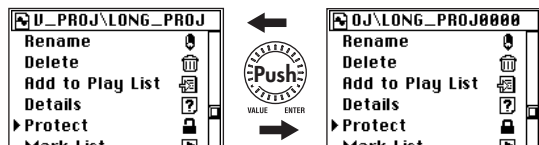

5. Each time you press the P-dial, the setting will alternate between protecting (🔒) and un-protecting (🔓) the project.

6. When you've finished making the setting, press the menu button to return to the library select (LIBRARY) screen.

Deleting a project/file

Here's how to delete a file. Once you've deleted a file, it cannot be recovered, so use this operation with care.

note You can't delete a project that's protected.

1. Press the menu button, and in the menu list (MENU) screen, use the P-dial to select and confirm "LIBRARY."

The library select (LIBRARY) screen will appear.

2. Use the P-dial to select and confirm the project/file that you want to delete. (See "Selecting and playing back a project/file," p.19)

To delete the currently selected project/file, simply press the P-dial twice.

- The project/file edit screen will appear, with the name of the currently selected and confirmed project/file shown at the time.
- Use the P-dial to select and confirm "Delete."
A screen will ask you to confirm the Delete operation.

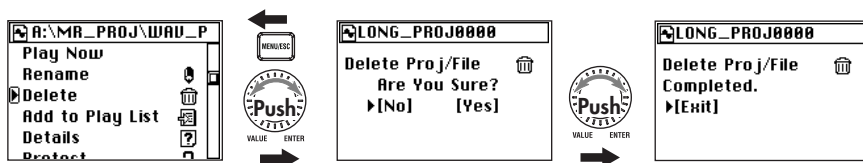

- Use the P-dial to select and confirm [Yes].
If you decide not to delete, use the P-dial to select and confirm [No] (or press the menu button), and you'll return to the file edit screen.
- The screen will indicate "Working...", and deletion will begin. When it ends, the screen will indicate "Complete."
- Press the P-dial (or the menu button) to return to the library select (LIBRARY) screen.

Viewing details about the project/file

Here's how to view detailed information about the project/file, such as the audio format, song time, and file size.

- Press the menu button, and in the menu list (MENU) screen, use the P-dial to select and confirm "LIBRARY."
The library select (LIBRARY) screen will appear.
- Use the P-dial to select and confirm the project/file whose detailed information you want to view. (See "Selecting and playing back a project/file," p.19)
If you want to view information for the currently selected project/file, simply press the P-dial twice.
- The file edit screen will appear, with the name of the currently selected file in the top line.
- Use the P-dial to select and confirm "Detail."
Details about the project/file will be displayed.

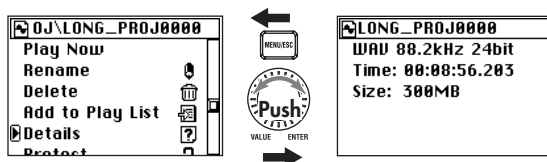

- When you've finished viewing the details, press the menu button to return to the project/file edit screen.

Other functions

Play mode

The MR-1000 provides three play modes, as well as shuffle and repeat play settings. To select these mode, use "PLAY MODE" in the menu list (MENU) screen.

Current Proj/File (play only one project/file)

In this mode, only the single project/file you select will play. (See "Selecting and playing back a project/file," p.19)

When the selected file has finished playing, playback will stop automatically.

note *This is the only mode in which you can use marks to move within the song during playback (→p.21).*

Current Folder (play the contents of a folder)

In this mode, each project/file in the folder that contains the current project/file will be played in the order it appears in the library select screen list.

When each project/file in the folder has finished playing, playback will stop automatically.

PlayList (play the contents of a list)

In this mode, the contents of the play list you create (→p.33) will be played.

When playback reaches the end of the play list, it will stop automatically.

Shuffle (shuffle playback)

If you select this option, the project/file playback order will be shuffled (randomized).

When playback ends, the order will automatically be shuffled, and then playback will continue. If you press the stop button and then press the play button, playback will continue from the beginning of the same project/file.

This setting is valid for the "Current Folder" or "PlayList" play modes.

note *If you enable "Shuffle", the "Repeat" setting is disabled. Conversely if you enable "Repeat", the "Shuffle" setting is disabled.*

Repeat (repeat playback)

If you select this option, playback will be repeated. This setting is valid for all play modes.

Playback according to

the selected mode will continue until you press the stop button.

note *If you enable "Repeat", the "Shuffle" setting is disabled. Conversely if you enable "Shuffle", the "Repeat" setting is disabled.*

1. Press the menu button, and in the menu list (MENU) screen, use the P-dial to select and confirm "PLAY MODE."

The play mode select (PLAY MODE) screen will appear.

2. Use the P-dial to select and confirm the playback method you want to use.

A check will appear in the check box of the play mode you selected and confirmed.

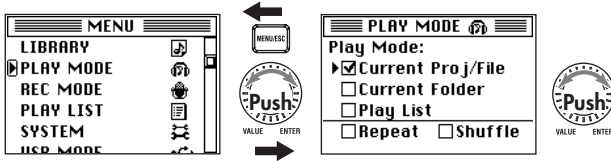

3. If you want to use shuffle play, check the "Shuffle" check box.

If the play mode is "Current Proj/File," this option is invalid even if it is checked.

4. If you want playback to repeat, check the "Repeat" check box.

5. Press the menu button to return to the menu list (MENU) screen.

6. When you press the play button, playback will begin, using the mode you selected.

Play list (PLAY LIST)

Creating a play list

After creating a play list, you can select "Play List" as the play mode, and the projects/files will be played in the order specified by the list. The repeat and shuffle settings of the Play Mode can affect the playback of the PlayList. You can store up to one hundred play lists. Here's how to create a play list.

1. Press the menu button, and in the menu list (MENU) screen, use the P-dial to select and confirm "LIBRARY."

The library select (LIBRARY) screen will appear.

2. Use the P-dial to select and confirm the project/file you want to add to the play list.
3. The name of the project/file you selected and confirmed will appear in the project/file edit screen displayed above.
4. Turn the P-dial to move the selection icon to "Add to Play List."

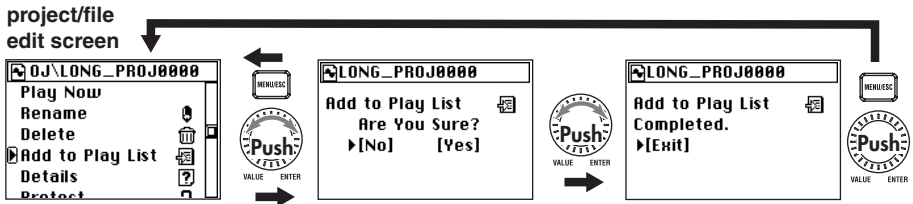

5. Press the P-dial; a message will ask "Add to Play List: Are you sure?"
6. Use the P-dial to select and confirm [Yes].
If you decide not to add the project/file, use the P-dial to select and confirm [No] (or press the menu button); you will return to the file edit screen.
7. The screen will indicate "Working...", and when processing is finished will indicate "Complete..."
The added project/file will be added to the end of the play list. If you want to change the order, refer to "Editing a play list" (p.34).
8. Press the P-dial (or the menu button) to return to the project/file edit screen.
9. If you want to add another project/file, press the menu button and repeat steps 2--9.

You can also use this procedure to add a project/file to a play list you created earlier.

Viewing a play list

Here's how to view the contents of a play list.

Press the menu button, and in the menu list (MENU) screen, use the P-dial to select and confirm "PLAY LIST."

The play list (PLAY LIST) screen will appear.

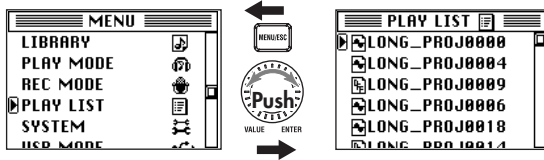

Editing a play list

In the play list (PLAY LIST) screen (see above), select the file you want to edit and then select the item you want to edit.

Play Now

Here's how to select a project/file from the list, and start playback.

1. In the **PLAY LIST** screen, use the **P-dial** to select and confirm the project/file whose order you want to change.
2. The play list edit screen will appear, with the name of the project/file you selected and confirmed shown at the top.
3. Use the **P-dial** to select and confirm "PlayNow"; the project/file shown at the top will begin playing.

In the play list screen, you can also press the play button to start playback of the project/file indicated by the selection icon.

Change Order

Here's how to change the order of a project/file in the list.

1. From the play list (**PLAY LIST**) screen, use the **P-dial** to select and confirm the project/file whose order you want to change.
2. The play list edit screen will appear, with the name of the selected and confirmed project/file shown at the top.
3. Use the **P-dial** to select and confirm "Change Order."

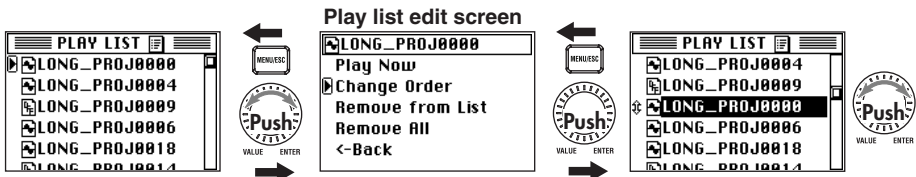

- The Move icon will appear in the play list (PLAY LIST) screen.
- Turn the P-dial to move the project/file to the desired position, and then press the dial to confirm.
The play list (PLAY LIST) screen will show the new order.

note If you press the menu button before you confirm, you will return to the play list edit screen.

Remove From List

Here's how to remove the selected project/file from the play list.

note This will not delete the project/file itself. If you later decide to add the project/file to the play list, you can use the Add to Play List operation to do so.

- In the play list (PLAY LIST) screen, use the P-dial to select and confirm the project/file that you want to remove from the list.
- The play list edit screen will appear, with the name of the selected and confirmed project/file shown at the top.
- Use the P-dial to select and confirm "Remove From List."

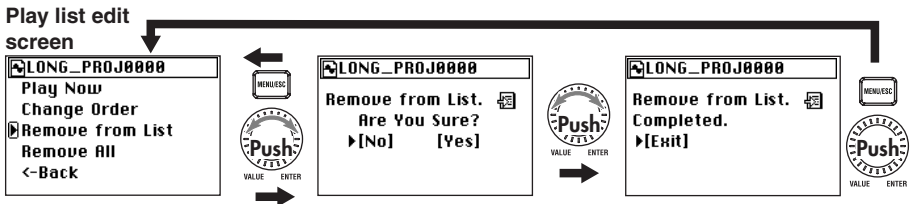

- A dialog message of "Remove From List. Are you sure?" will appear in the screen.
- Use the P-dial to select and confirm [Yes].
If you decide not to remove the project/file, use the P-dial to select and confirm [No] (or press the menu button), and you will return to the play list edit screen.
- The screen will indicate "Working...", and will then indicate "Complete" when the project/file has been removed.
- Press the P-dial (or the menu button) to return to the play list edit screen.
- If you want to remove another project/file, press the menu button and repeat steps 1--7.

Remove All

Here's how to remove all projects/files from the play list.

note This will not delete the projects/files themselves.

- In the play list (PLAY LIST) screen, use the P-dial to select and confirm any project/file.
- The play list edit screen will appear.
- Use the P-dial to select and confirm "Remove All."

4. The screen dialog will ask "Remove All. Are you sure?"

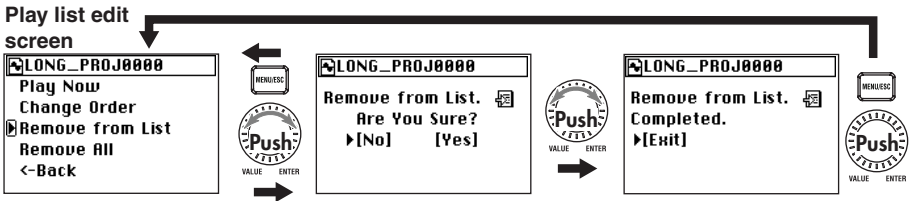

5. Use the P-dial to select and confirm [Yes].

If you decide not to execute this operation, use the P-dial to select and confirm [No] (or press the menu button), and you will return to the play list edit screen.

6. The screen will indicate "Working...", and will then indicate "Complete" when the project/file has been removed.

7. Press the P-dial (or the menu button) to return to the play list screen.

8. Verify that the entire list has been deleted, and press the menu button to return to the menu list screen.

Record mode

Here you can make various settings related to recording.

Press the menu button, and in the menu list (MENU) screen, use the P-dial to select and confirm "REC MODE."

You can make the following settings from the record mode (REC MODE) screen.

Project recording format (New Project Type)

WAV (BWF)

This is an uncompressed linear PCM multi-bit audio file format. The sampling frequency and bit-depth are selected by the PCM Format settings described below.

The name is an abbreviation of Wave File Format (file extension .wav). This format is compatible with the Broadcast Wave Format (file extension .wav) used for broadcast audio.

A higher sampling rate and bit depth allows higher-quality recording, but will require more hard disk space.

DFF (DSDIFF)

This is a 1-bit audio file format widely used in professional audio devices for SACD (Super Audio CD) production.

The name stands for Direct Stream Digital Interchange File Format (file extension .dff).

DSF

This is a 1-bit audio file format used in some "VAIO" personal computers made by Sony.

The name stands for DSD Stream File (file extension .dsf).

WSD

This is a 1-bit audio file format defined by the "1-bit Audio Consortium."
The name stands for Wideband Single-bit Data (file extension .wsd).

Settings when WAV (BWF) is selected

If you select WAV (BWF), you can also select the sampling frequency and bit depth. At sampling frequencies of 88.2 kHz and higher, the bit depth will always be 24.

Settings when DFF, DSF, or WSD are selected

If you've selected a 1-bit format, use the 1bit DSD Format : Fs setting to specify the sampling frequency.

Recording time for each format (per 1Gbyte)

The following table shows the approximate recording time available in each format per 1 Gbyte of hard disk capacity.

WAV Format	Recordable time	1bit Format	Recordable time
WAV 44.1kHz/16bit	90 minutes	DFF 2.8MHz	22 minutes
WAV 44.1kHz/24bit	60 minutes	DFF 5.6MHz	11 minutes
WAV 48kHz/16bit	85 minutes	DSF 2.8MHz	22 minutes
WAV 48kHz/24bit	55 minutes	DSF 5.6MHz	11 minutes
WAV 88.2kHz/24bit	30 minutes	WSD 2.8MHz	22 minutes
WAV 96kHz/24bit	25 minutes	WSD 5.6MHz	11 minutes
WAV 176.4kHz/24bit	15 minutes		
WAV 192kHz/24bit	13 minutes		

System settings (SYSTEM)

Here you can make various system settings for the MR-1000 itself.

Press the menu button to access the menu list (MENU) screen. Then use the P-dial to select and confirm "SYSTEM" and make the desired settings.

The "Back Light," "AutoShutDown," and "LED" settings are explained in "Conserving battery power" (p.26), and the "Clock" setting is explained in "Setting the date and time" (p.28).

LCD Contrast

Here you can set the LCD contrast. Higher settings will make the black portions of the display darker. Adjust the value for best visibility.

1. In the system setting (SYSTEM) screen, use the P-dial to select and confirm "LCD Contrast."

The selection icon will change from "▶" to "▷", and the value will be highlighted.

2. Turn the P-dial, and the contrast will change along with the value.

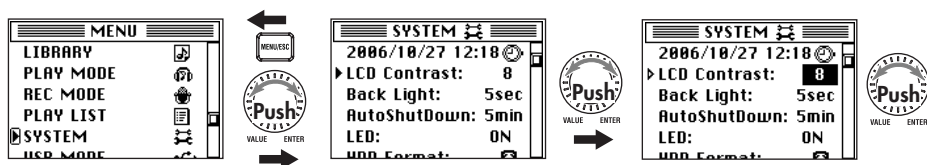

3. When you've adjusted the contrast for best visibility, press the P-dial (or the menu button) to complete the setting.

The selection icon will change from "▷" to "▶".

Device information (Device Info)

Here you can view the version of the MR-1000's system software, the total capacity of the hard disk, the free capacity, and the number of recorded projects/files.

1. In the system setting (SYSTEM) screen, use the P-dial to select and confirm "DeviceInfo."

The information (Device Information) screen will appear.

2. When you've finished viewing the information, press the P-dial (or the menu button) to return to the system setting (SYSTEM) screen.

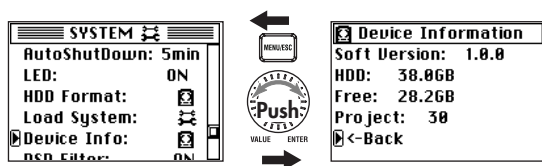

DSD output filter settings (DSD Filter)

If you turn this setting on, the sound when playing a 1-bit project/file will pass through the signal processing filter. By default, this is "ON".

ON: Playback will pass through the DSD filter (-3.0 dB at the pass frequency of 50 kHz).

OFF: The 1-bit signal will play back directly without going through the DSD filter.

 *Noise or extraneous sound may occur if you connect this to a device that does not support wideband audio input. Before turning this setting off, you must check the owner's manual of the connected device.*

1. **Press the menu button, and from the menu list (MENU) screen, use the P-dial to select and confirm "SYSTEM."**

The system setting (SYSTEM) screen will appear.

2. **Use the P-dial to select and confirm "DSDFilter".**

The selection icon will change from "▶" to "▷", and the value of the setting will be highlighted.

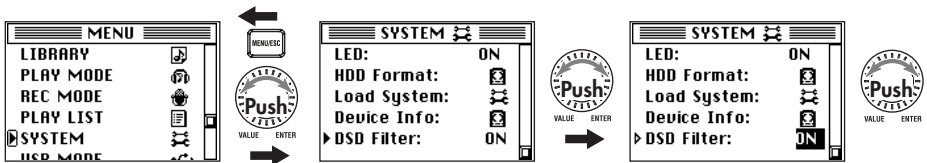

3. **Turn the P-dial to select "OFF".**

If you want to turn the setting on, select "ON" in the same way.

4. **Press the P-dial (or the menu button) to complete the setting.**

The selection icon will change from "▷" to "▶".

Formatting the hard disk (HDD Format)

Here's how to format the MR-1000's hard disk.

You should only perform this operation if you want to erase all of the data saved on the hard disk, or if the message "Drive Error." appears frequently.

All data will be erased from the hard disk when you execute this operation, so you should use it with caution.

Before executing this operation, you should make a backup of any data you want to keep. (→p.42 "Using the MR-1000 with your computer")

 *If a power failure or similar accident occurs during formatting, the MR-1000 may become inoperable. If this occurs, please contact Korg customer service.*

1. Press the menu button, and in the menu list (MENU) screen, use the P-dial to select and confirm "SYSTEM."

The system setting (SYSTEM) screen will appear.

2. Use the P-dial to select and confirm "HDD Format."

3. A dialog message of "HDD Format : Are you sure?" will appear in the screen.

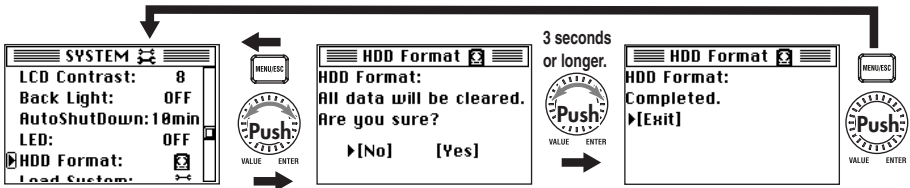

4. Use the P-dial to select [Yes], and continue holding it for three seconds or longer.
If you decide not to format the hard disk, use the P-dial to select and confirm [No] (or press the menu button); you will return to the system setting (SYSTEM) screen.
5. The screen will indicate "Working...", and when formatting is finished the indication will change to "Complete."
6. Press the P-dial (or the menu button) to return to the system setting (SYSTEM) screen.



Updating the system (Load System)

You can download the latest version of the MR-1000 operating system file from the Korg website (www.korg.com). For details on the procedure, refer to the Korg website.

Preparing for the update

Use a USB cable to connect the MR-1000 to your computer (see "Using the MR-1000 with your computer," p.42), and copy the downloaded system file to the root folder of MR-1000's hard disk.

Update procedure

-  If you do not use the AC adaptor as the power supply, an error message will appear, and it will not be possible to load the system.
-  If a power failure or similar accident occurs while loading the system, the MR-1000 may become inoperable. If this occurs, please contact Korg customer service.

1. Press the menu button, and in the menu list (MENU) screen, use the P-dial to select and confirm "SYSTEM."
The system setting (SYSTEM) screen will appear.
2. Use the P-dial to select and confirm "Load System."
3. A dialog message of "Load System : Are you sure?" will appear in the screen.

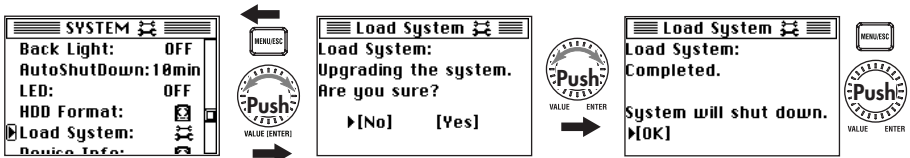

4. Use the P-dial to select and confirm [Yes].
The screen will indicate "Load System: Working..." and the system will be loaded.
 5. When the system has finished loading, the display will indicate "System will shut down. [OK]"
 6. Press the P-dial (or the menu button); the MR-1000 will shut down and the power will turn off.
 7. Press and hold down the power button to turn on the power; the MR-1000 will start up with the newly loaded system.
-  If the update fails, a message will appear. Make a note of the contents, and take the appropriate action (→p.49 "Various messages").

Using the MR-1000 with your computer

You can use the MR-1000 as a USB 2.0 mass storage class device.

This lets you copy files from the MR-1000 to your computer, or copy files (WAV, DSDIFF, etc.) from your computer into the MR-1000.

⚠ *There are limitations on the audio files that the MR-1000 can recognize (→p.44).*

⚠ *You must use the included AC adaptor when entering USB mode*

USB mode

In this mode, the MR-1000 will be detected by your computer as an external hard disk. The MR-1000 won't operate as a recorder while it is in USB mode.

Entering USB mode

1. Connect the MR-1000 to your computer.

Windows users (Windows Me/2000 or later)

Use a USB cable to connect the MR-1000's USB connector to your computer's USB connector.

Make sure that the connector is oriented correctly, and insert it all the way.

Press the menu button, and from the menu list (MENU) screen, use the P-dial to select and confirm "USB MODE."

note *The MR-1000 will start up in USB mode if the USB cable is connected when you turn on the power.*

Macintosh users (Mac OS 9.0.4 or later)

With the MR-1000 powered-off, connect the USB cable to the Macintosh. Make sure that the connector is oriented correctly, and insert it all the way.

When you power-on the MR-1000, it will automatically enter USB mode.

2. The USB mode (USB MODE) screen will appear.



⚠ *While this screen is displayed, you must not disconnect the USB cable or turn the power of your computer on or off.*

3. A drive named "Local disk (*)" (or "Unspecified name") will be added to your computer.

When you connect the MR-1000 to your computer for the first time, the device driver will be installed automatically.

4. Save data on your computer.

When you open the "Local disk (*)" (or "Unspecified name") that appeared on your computer in step 3, the contents of the MR-1000's hard disk will be displayed.

Copy the desired data onto your computer. You can also copy data from your computer into the MR-1000's hard disk.

 *Don't disconnect the USB cable while a file is being transferred.*

Exiting USB mode

1. Disconnect the MR-1000 from your computer.

Windows users (Windows Me/2000 or later)

Left-click the icon shown in the right side of your computer's taskbar.

In the menu that appears, left-click "Safely remove USB mass storage device (drive name)."

Verify that a message indicating "You may safely remove the USB mass storage device" is displayed. In Windows

Me, "USB mass storage device" is shown as "USB disk."

Macintosh users (Mac OS 9.0.4 or later)

Drag the drive from the desktop into the "Trash," or choose "Trash" from the "File" menu.

2. Press the P-dial (or the menu key) to return to the menu list (MENU) screen

After returning to the menu list (MENU) screen, disconnect the USB cable.

Transferring files

The files you record on the MR-1000 are saved in automatically-created project folders for each recording format (WAV, DFF, DSF, WSD) within the MR_PROJ folder. You can back-up your files by copying these folders to your computer.

These folders contain the following two files.

- Audio data files (.wav/.dff/.dsf/.wsd): These files contain the recorded audio
- Project data files (.prj): These files contain information such as project settings and marks

 *Do not change the names of these two files. Doing so may make them unplayable on the MR-1000.*

To restore data that you previously backed-up, copy the files into the folder for the appropriate recording format.

If you want to transfer audio data (.wav/.dff/.dsf/.wsd) created on your computer or other device, copy it into the AUDIO folder.

Hard disk structure and files

Supported audio files

Stereo files are used for all recording formats that can be selected on the MR-1000 (→p.36)

Supported folders and file names

FAT32 file system format. Long file names are supported, double-byte characters (e.g., Japanese) are not supported.

Folder/file structure

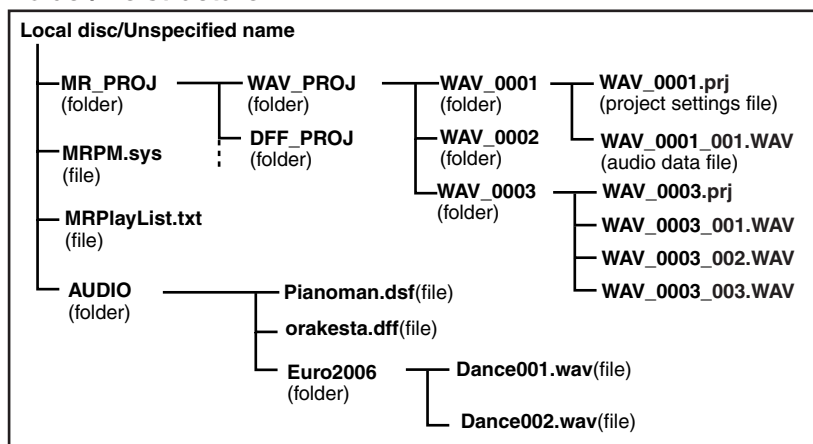

MR_PROJ folder

This folder contains the folders for each format recorded by the MR-1000.

⚠ *Don't use your computer to delete or rename the MR_PROJ folder. If you do so, the MR-1000 will no longer recognize the files you created.*

WAV_PROJ, DFF_PROJ, DSF_PROJ, WSD_PROJ folders

For each format, a maximum of two hundred project folders can be created within each of these folders.

The MR-1000 is only able to edit recorded files that are inside these folders.

⚠ *Up to 200 project files can be recognized within a folder. If there are more than 200 project folders, they can be recognized by connecting a computer in USB mode.*

⚠ *The maximum number of project folders that can be created will be limited by the space remaining on the hard disk.*

⚠ *Don't use your computer to delete or rename folders or files in these folders. This may make it impossible to recognize the projects or files you created.*

⚠ *Audio data you created on your computer or other device will not be recognized if you place it in these project folders.*

MRPM.sys

This file contains settings used by the system. There must be one and only one such file. Do not move or delete it.

 *Never delete or rename this file.*

MRPlayList.txt

This file contains a play list.

 *Do not rename this file.*

WAV_0001 folder (project folder)

This folder is created for each project you record. The numerical portion of the folder name will be incremented, starting with 0001. The first three alphabetical characters will depend on the recording format. Operations on the MR-1000 apply to the project recorded in this project folder. Renaming the project will rename the project folder, and the name of the project setting file within the folder will also be renamed automatically.

note *If you use your computer to rename a project folder, you must also spy the same name for the project setting file (***.prj) within that folder.*

Files inside the WAV_0001 folder (project folder)

WAV_0001.prj (project settings file)

This is a file specific to the MR-1000, containing information (protect setting, mark data, etc.) for each recorded project. Only one file with this extension (.prj) can exist in each project folder.

WAV_0001_001.wav (audio data file: wav)

These are stereo audio data files. The extension (.wav) will depend on the recording format.

When the file is recorded, the file name and the extension will be as follows.

WAV_0001_001.wav	Recording format extension
Project name (This will not be updated even if you rename.)	WAV(BWF)--- .wav
The file is divided (into a maximum of ninety nine files), with this area being "1" if the file size is 1 GB or less, and "1", "2" ... etc. if the size is greater than 1 GB. Even if the file size is less than 1 GB, the file will be divided if you pause during recording.	DSDIFF----- .dff
	DSF----- .dsf
	WSD----- .wsd

AUDIO folder

This folder is used to hold audio data that was created on your computer or another device.

You cannot edit these files on the MR-1000, but you can add them to a play list and play them. You can create up to four levels within a folder, but the MR-1000 is able to recognize only up to a total of two hundred folders and files within this folder.

 *You must not rename this folder.*

WAV_0001
Recording number A number from 0001 to 9999 assigned automatically to each recording in a format folder, in sequential order
Format identification symbol WAV(BWF), DSDIFF, DSF, WSD

Using the AudioGate software

The audio files of a project recorded on the MR-1000 can be copied to your computer. Then you can use the "AudioGate" audio format conversion application on the included CD to convert the audio file format; as well as edit, divide, or join audio files.

For details, install the software from the included CD and refer to the AudioGate operating manual (PDF).

Installing AudioGate

Contents of the CD-ROM

The included CD-ROM contains the following items.

- "AudioGate" format conversion application
- AudioGate operating manual (PDF)
- Software license agreement (PDF)

Please read before use

- All copyrights to this software are the property of Korg Corporation.
- A license agreement for the software of this product is included separately. You must read this software license agreement before you install the software. Your installation of this software will be taken to indicate your acceptance of this agreement.

Operating requirements

Windows XP

Supported operating systems

Microsoft Windows XP Home Edition/Professional Edition Service Pack 1 or later

Supported computers

CPU: Intel Pentium III / 1 GHz or better

RAM: 256 MB or more

A USB port that meets the operating requirements of Microsoft Windows XP

Mac OS X

Supported operating systems

Mac OS X 10.3.9 or later

Supported computers

CPU: Apple G4 / 800 MHz or better

RAM: 256 MB or more

A USB port that meets the operating requirements of Mac OS X

Windows XP users

note *In order to install or uninstall software in Windows XP, you must have Administrator privileges. For details, consult your system administrator.*

1. Insert the included CD-ROM into the CD-ROM drive of your computer.

Normally, the "AudioGate Application Installer" will start up automatically.

If your computer is set so that the installer will not start up automatically, double-click "KorgSetup.exe" in the CD-ROM.

2. Follow the on-screen instructions to proceed with the installation.

3. When you've finished installing AudioGate, exit the installer.

Mac OS X users

1. Insert the included CD-ROM into the CD-ROM drive of your computer.

2. In the CD-ROM, double-click the AudioGate installer (.pkg) to start up the installer.

3. Follow the on-screen instructions to proceed with the installation.

4. When you've finished installing AudioGate, exit the installer.

Appendix

Troubleshooting

Power does not turn on

- Is the AC adaptor connected correctly?
- Is there any remaining battery capacity?
- Did you hold down the power button?

Nothing appears in the display

- Is the contrast adjusted correctly? (→p.38)

Display is dark

- Is the backlight set to "OFF"? (→p.26)

No sound

- Is the MR-1000 and the connected equipment powered-on? (→p.13)
- Are the amp or headphone connections incorrect?

Can't hear the playback

Headphones

- Is the headphone volume set to "0"?

Can't hear the audio input

- Are the recording settings correct?
- Is the recording level raised?
- Make sure that audio is being input.
In the level meter screen, verify that the level meters are moving.

Can't record

- Are the input level L/R knobs lowered?
- Is there sufficient hard disk space remaining?
→ Set the counter display to "Free" and check the remaining time available for recording.
(→p.24)

The recording is interrupted

- Could the MR-1000 have been bumped while recording?
- Could the MR-1000 have been in a location subject to continuous vibration (such as near a motor or a bass amp) while recording?

Nothing happens when you press a button

- In some cases, the buttons may be less responsive while the recording is operating, such as during playback or recording.
→ Hold down the button until the action occurs.

USB

Your computer does not detect the MR-1000

- Is the USB cable connected correctly? (→p.42)
→ Re-connect the cable..

Can't release the MR-1000 from your computer

- The procedure will depend on the operating system of your computer. (→p.42)

When you connect the MR-1000, you are asked to install software or a device driver

- Does the MR-1000 support the version of the operating system your computer is running? (→p.42)

Various messages

The message dialog box will disappear when you press the P-dial.

Execution messages

Completed

- The operation has been successfully completed.

Working...

- The operation is being carried out. Please wait until this message disappears.

Error messages

Cannot execute.

- This operation cannot be performed at this time.

Can not execute Load System. Use AC Adaptor, Please.

- The AC adaptor is not connected, so the system load operation cannot be executed.
→ Connect the AC adaptor, and then load the system

Check Sum Error.

- The system could not be loaded.
→ Try the operation once again from the beginning. If this message appears again, please contact customer service.

Disk too busy.

- Repeated actions of recording, writing, and deleting will gradually decrease the amount of contiguous free space on the hard disk, causing files to be saved in a fragmented state during recording. This message will appear when access to the drive has slowed down due to such problems.
 - Back up your important files, format the hard disk, and then restore your files back onto the hard disk.
 - Alternatively, delete unneeded files to increase the amount of free space, and then connect the MR-1000 to your computer in USB mode and optimize the drive. It is effective to use software of a type that optimizes the free space.

Drive Error.

- An error occurred while accessing the drive.
 - Use USB mode to connect the MR-1000 to your computer and execute the Check Drive command.
 - If this error message appears even after you've executed Check Drive, format the drive.

Drive Full.

- There is insufficient remaining capacity on the drive.
 - Delete unneeded projects/files.

Failed to write System File.

- The system update has failed.
 - It is possible that the MR-1000 has malfunctioned. Please contact customer service.

Memory Full.

- You attempted to register more than 100 marks. No further marks can be registered.
 - Delete unneeded marks before registering other marks.

Not supported file.

- This file format is not supported.
 - Check the audio file formats that are supported.

Please enter name.

- There is no project name (the name consists only of spaces).
 - Please enter a valid project name (one or more alphabetical character, numeral, or symbol).

Protected Project.

- The operation cannot be executed because the project is protected.
 - Turn off the project protect setting.

Project Name Error. Delete illegal folder.

- An identically named project/file already exists.
 - Rename the project/file. Alternatively, use USB mode to delete the project/file and the directory of the same name.

System File Error.

- The system file required for "Load System" does not exist, or the length of the file does not match.
 - Check the system file and re-save it.

Time Limit.

- The maximum continuous recording time is 6 hours. No further continuous recording is possible.

Warning: Bad fragmentation. Should be optimized.

This message will appear when you enter record-ready mode if there is a possibility that the "Disk too busy." error might occur during recording because of insufficient contiguous free space on the hard disk.

Normally, a minimum of ten minutes of contiguous free space will be allocated if there is ten minutes or more free capacity; if there is less than ten minutes of free capacity, as much as exists will be allocated.

It is not necessarily the case that the "Disk too busy." error will always occur if this warning appears, but we recommend that you take the following actions.

- Back up your important files, format the hard disk, and then restore your files back onto the hard disk.

Alternatively, delete unneeded files to increase the amount of free space, and then connect the MR-1000 to your computer in USB mode and optimize the drive. It is effective to use software of a type that optimizes the free space.

Confirmation messages

Info : # # # # #

- This will appear if there is information to be conveyed to the user.
 - Press the menu button or the P-dial to continue operations.

Serious error messages

Fatal : # # # # #

- This will appear if the MR-1000 itself has a problem or malfunction.
 - If this type of message appears, make a note of the text in "# # # # #" and contact customer service.

Specifications

Operating conditions: +5 ... +35 °C (no condensation)

Main sections

< Recorder section >

- Number of tracks : 2 tracks
: 2 tracks simultaneous playback / 2 tracks simultaneous recording
- Recording formats : PCM audio format
WAV format (extension .wav), BWF compliant
44.1 kHz @ 16/24-bit, 48 kHz @ 16/24-bit
88.2 kHz @ 24-bit, 96 kHz @ 24-bit
176.4 kHz @ 24-bit, 192 kHz @ 24-bit
: 1-bit audio format 2.8 MHz @ 1-bit/5.6MHz @ 1-bit
DSDIFF format (extension .dff), DSF (extension .dsf),
WSD (extension .wsd)
- Recording : Maximum 60 hours @ 44.1 kHz/16-bit (for 40 Gbyte hard disk)
: Maximum continuous recording 5 hours 59 minutes 59 seconds 999
- Number of projects: Recognizes a maximum of two hundred projects of each format
- Mark points : 100 points per project *No mark names
- USB functionality : Connect to computer via USB 2.0, usable as FAT32 USB external drive
- Song editing : Rename, Delete, Protect

< General >

- Display : 160 x 104 pixel, LCD with backlight
- Power supply : Included AC adaptor,
separately: eight AA alkaline batteries (LR6), Oxyride batteries, or
charged nickel metal-hydrate batteries.
- Power consumption : 7 W
- Dimensions : 192 mm (W) x 170 mm (D) x 56 mm (H)
: 7.56" (W) x 6.69" (D) x 2.20" (H)
- Weight : 1.0kg /2.2 lbs(without battery)

Main specifications

- Frequency response : 10 Hz ... 20 kHz \pm 1 dB @ Fs 44.1 kHz / 48 kHz
10 Hz ... 40 kHz \pm 1 dB @ Fs 88.2 kHz / 96 kHz /176.4 kHz / 192 kHz
10 Hz ... 100 kHz (1-bit)
- S/N : 96 dB (typical) @ IHF-A
- THD+N : 0.008% (typical), 20 Hz ... 20 kHz

A/D conversion : 2.8224MHz/5.6448MHz (1-bit), 24-bit (PCM)

D/A conversion : 2.8224MHz/5.6448MHz (1-bit), 24-bit (PCM)

<INPUT L, R>

Connector : XLR-3-31 type (+48V phantom power, switchable)/
1/4" TRS phone Jack (balanced)

Input impedance : 4.5 k Ω (XLR)/68 k Ω (TRS)

Nominal level : - 60 dBu...- 28 dBu, XLR (balanced)
- 26 dBu...+ 4 dBu, 1/4" TRS phone (balanced)
- 26 dBV...- 6 dBV, 1/4" TRS phone (Unbalanced)

Maximum level : - 16 dBu, XLR (balanced)
+ 16 dBu, 1/4" TRS phone (balanced)
+ 6 dBV, 1/4" TRS phone (Unbalanced)

<OUTPUT L, R(Unbalanced/Balanced)>

Connector : RCA (Unbalanced)/XLR-3-32 type (balanced)

Nominal level : - 6 dBV/+ 4 dBu

Maximum level : + 6 dBV/+ 16 dBu

Load impedance : 47 k Ω or greater/600 Ω or greater

<PHONES>

Connector : 1/4" stereo phone jack

Load impedance : 16 Ω or greater

Maximum level : 50 mW + 50 mW @ 32 Ω

<USB>

Connector : Type B

Format : USB 2.0 compliant, USB mass storage class

Supported operating systems: Windows Me, 2000, or later Mac OS 9.0.4 or later

Included items

AC adaptor (also operates as charger), owner's manual (this document), carry bag,
CD-ROM ("AudioGate" audio file conversion application)

Demo Project

All Most Blues
The Wind and the Wheat

performed by Phil Keaggy
copyright Phil Keaggy 2006
www.philkeaggy.com

* Appearance and specifications are subject to change without notice.

Index

Menu list screen

MENU

LIBRARY -----	19
PLAY MODE -----	31
REC MODE -----	16, 36
PLAY LIST -----	33
PlayNow -----	34
Change Order -----	34
Remove From List -----	35
Remove All -----	35
SYSTEM -----	38
2006/01/01 10:52 -----	28
LCDContrast -----	38
BackLight -----	26
AutoShutDown -----	13, 27
LED -----	27
HDD Format -----	40
Load System -----	41
Device Info -----	38
DSD Filter -----	39
USB MODE -----	42

Project/file edit screen

LIBRARY

Project/File

Rename -----	24
Protect -----	29
Delete -----	29
Add to Play List -----	33
detail -----	30
Mark List -----	21

Meter/counter screen

METER

Meter/Counter

meter peak hold -----	24
Counter mode -----	24

Mark edit select screen

Mark List

Mark Edit

00:00:00.000 -----	22
Delete Mark -----	23
Delete All Mark -----	23

A

- AUDIO folder ----- 45
- Auto Shutdown ----- 13, 27

B

- Backlight ----- 26

C

- Computer ----- 42
- Conserving battery power ----- 26
- Counter ----- 15, 24

D

- Date and time ----- 28
- Delete ----- 29
- Detail ----- 30
- Device information ----- 38
- DSD Filter ----- 39

E

- Error messages ----- 49

F

- Format ----- 40

L

- LCD contrast ----- 38
- LED setting ----- 27
- Limiter ----- 20

M

- Mark ----- 21
- Mic input ----- 16

P

- Peak hold ----- 15, 24
- Play list ----- 33
- Play mode ----- 31
- Playback ----- 14, 19
- Project ----- 14
- Project/file name ----- 24
- Protect ----- 15, 29

R

- Record mode ----- 36
- Recordable time ----- 37
- Recording ----- 16
- Recording format ----- 16, 36
- Recording level ----- 17
- Rename ----- 24
- Repeat ----- 31

S

- Shuffle ----- 31
- Supported audio files ----- 44
- Supported file names ----- 44
- System settings ----- 38

T

- Troubleshooting ----- 48

U

- Updating the system ----- 41
- USB mode ----- 42

IMPORTANT NOTICE TO CONSUMERS

This product has been manufactured according to strict specifications and voltage requirements that are applicable in the country in which it is intended that this product should be used. If you have purchased this product via the internet, through mail order, and/or via a telephone sale, you must verify that this product is intended to be used in the country in which you reside.

WARNING: Use of this product in any country other than that for which it is intended could be dangerous and could invalidate the manufacturer's or distributor's warranty.

Please also retain your receipt as proof of purchase otherwise your product may be disqualified from the manufacturer's or distributor's warranty.

KORG KORG INC.

4015-2 Yanokuchi, Inagi-city, Tokyo 206-0812 Japan