

SONY®

IC Recorder

Operating Instructions

Click! You can direct jump

Table of contents

Recording files

Utilizing your computer

Troubleshooting

Index

GB

4-293-033-13(1)

Table of Contents

WARNING	5
Notice for users	7

Preparing the recorder

Checking the Parts and Controls	8
Using the Display Window.....	10
Preventing Unintentional Operations (HOLD)	16
Maintaining the Moderate Volume Level (AVLS) (For European models only).....	17
Recharging the Battery.....	18
Recharging the battery using a computer	18
Recharging the battery using a USB AC adaptor	19
Inserting a Memory Card.....	20
Turning the IC Recorder On	22
Turning the power on.....	22
Turning the power off	22
Setting the Clock	23
Setting the clock after recharging the battery.....	23
Setting the clock using the menu.....	24
Setting the Language to Be Used in the Display Window.....	26
Selecting a Folder, File, Tab, and Memory	27
Selecting a folder and a file.....	27
Selecting a tab.....	28
Selecting the memory.....	29

Recording Files

Basic Recording	31
Monitoring the recording	32
Stopping the recording.....	33
Other operations.....	33
Changing the Recording Settings	34
Selecting a recording scene for each situation.....	34
Tips for better recording	35
Changing the Scene Select settings.....	36
Changing the Scene Select setting to the default values.....	37
Starting to Record Automatically in Response to Sound – the VOR Function	38

Recording via Other Devices	39
Recording with an external microphone	39
Recording from other equipment.....	40

Playing Files

Basic Playback	42
Stopping playback.....	42
Other operations.....	43
Display when playing back a file.....	44
Changing the Playback Settings.....	45
Reducing noise in the playback sound and making the human voice clearer – the noise cut function.....	45
Adjusting the playback speed – the DPC (Digital Pitch Control) function	46
Selecting the sound effect	47
Selecting the playback mode	49
Convenient playback methods.....	51
Selecting a Recording Date from the Calendar and Playing Back	52
Playing Back a File at a Desired Time with an Alarm	54
Playback via Other Devices.....	56
Recording with other equipment.....	56

Erasing Files

Erasing a File	57
Erasing All Files in a Folder	58

Editing Files

Arranging Files in a Folder	59
Moving a file to a different folder	59
Copying a file to the other memory	60
Using a Track Mark	61
Adding a track mark.....	61
Erasing a track mark.....	62
Erasing all the track marks in the selected file at one time	63
Dividing a File	64
Dividing a file at the current position.....	64
Dividing a file at all the track mark positions	65
Renaming a Folder and a File.....	66
Changing a folder name.....	66
Changing a file name.....	67
Protecting a File.....	68

Listening to the FM Radio (ICD-UX522F/UX523F only)

Tuning in an FM Radio Station.....	69
Tuning in a radio station by scanning frequencies	69
Tuning in a preset radio station	70
Recording FM broadcasts	71
Presetting FM Radio Stations	72
Presetting FM radio stations automatically.....	72
Presetting FM radio stations manually	73
Erasing preset FM radio stations	74
Changing the FM Radio Reception Settings	75
Switching the receiver sensitivity of the FM radio.....	75
Switching the scanning sensitivity.....	76
Switching the FM radio output between speaker and headphones	77

About the Menu Function

Making Settings for the Menu.....	78
Menu Settings	79

Utilizing Your Computer

Using the IC Recorder with Your Computer	95
Connecting the IC recorder to your computer	96
Structure of folders and files.....	97
Disconnecting the IC recorder from your computer	100
Copying Files from the IC Recorder to Your Computer	101
Copying Music Files from Your Computer to the IC Recorder and Playing Them Back	102
Copying a music file from your computer to the IC recorder (drag and drop)	102
Playing back music files copied from your computer using the IC recorder	103
Using the IC Recorder as USB Memory	104
Using the Supplied Sound Organizer Software.....	105
What you can do using Sound Organizer.....	105
System requirements for your computer	107
Installing Sound Organizer	108
The Sound Organizer window.....	110

Additional Information

Using a USB AC Adaptor.....	111
Disconnecting the IC recorder from the AC outlet	112
Precautions	113
Specifications.....	115
System requirements	115
Design and specifications	117
Battery life.....	120

Troubleshooting

Troubleshooting	121
On the IC recorder operations	121
On the Sound Organizer.....	129
Messages List	131
System Limitations	134
Trademarks.....	135
Listening for a Lifetime	136
Index	138

Note

- Depending on the country/region in which you have purchased the IC recorder, some models may not be available.

Browsing the Operation Guide

To use the buttons in the Operation Guide

Click the buttons located in the upper right of the pages of this manual to jump to “Table of Contents,” or “Index.”

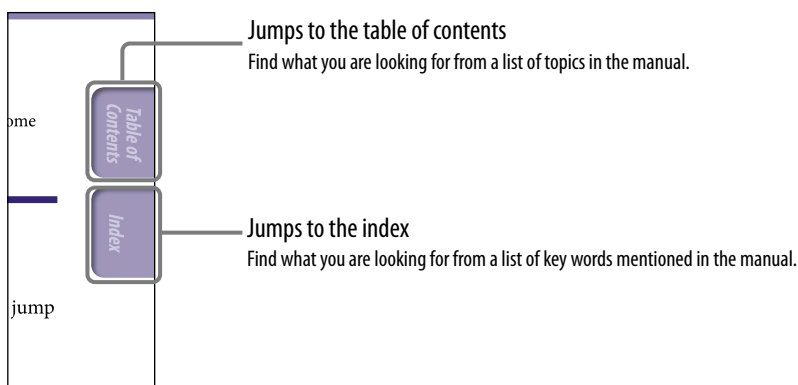

Hints

- You can jump to the indicated page by clicking a page number in the table of contents or in the index.
- You can jump to the indicated page by clicking a page reference indication (e.g.,  p. 6) on each page.
- To search for a reference page by keyword, enter the keyword into the find text field on the Adobe Reader window.
- Operation procedures may differ, depending on your Adobe Reader version.

To change the page layout

The buttons on the Adobe Reader window enable you to select how pages are displayed.



Text field to find text

Continuous

Pages are displayed as a continuous roll of pages, fitting the page width inside the window. When you scroll, the previous or next pages scroll up or down continuously.

Single Page

Pages are displayed one at a time, fitting the page into the window. When you scroll, the display changes to the previous or next page.

WARNING

Do not expose the batteries (battery pack or batteries installed) to excessive heat such as sunshine, fire or the like for a long time.

CAUTION

Risk of explosion if battery is replaced by an incorrect type.
Dispose of used batteries according to the instructions.

- The recorded music is limited to private use only. Use of the music beyond this limit requires permission of the copyright holders.
- Sony is not responsible for incomplete recording/downloading or damaged data due to problems of the IC recorder or computer.
- Depending on the types of the text and characters, the text shown on the IC recorder may not be displayed properly on device. This is due to:
 - The capacity of the connected IC recorder.
 - The IC recorder is not functioning normally.
 - Content information is written in the language or the character that is not supported by the IC recorder.

For the customers in China

RATED CURRENT

CONSUMPTION: 800 mA

AC adaptor: AC-NWUM50

For users in France

At high volume, prolonged listening to the personal audio player can damage the user's hearing.



If you need to replace the headphones/earphones, please refer to the headphones/earphones model corresponding to your device and indicated below.

MDR-E706

Disposal of Old Electrical & Electronic Equipment (Applicable in the European Union and other European countries with separate collection systems)

This symbol on the product or on its packaging indicates that this product shall not be treated as household waste. Instead it shall be

handed over to the applicable collection point for the recycling of electrical and electronic equipment. By ensuring this product is disposed of correctly, you will help prevent potential negative consequences for the environment and human health, which could otherwise be caused by inappropriate waste handling of this product. The recycling of materials will help to conserve natural resources. For more detailed information about recycling of this product, please contact your local Civic Office, your household waste disposal service or the shop where you purchased the product.

Applicable accessory: Headphones

Disposal of waste batteries (applicable in the European Union and other European countries with separate collection systems)



This symbol on the battery or on the packaging indicates that the battery provided with this product shall not be treated as household waste.

On certain batteries this symbol might be used in combination with a chemical symbol. The chemical symbols for mercury (Hg) or lead (Pb) are added if the battery contains more than 0.0005% mercury or 0.004% lead.

By ensuring these batteries are disposed of correctly, you will help prevent potentially negative consequences for the environment and human health which could otherwise be caused by inappropriate waste handling of the battery. The recycling of the materials will help to conserve natural resources.

In case of products that for safety, performance or data integrity reasons require a permanent connection with an incorporated battery, this battery should be replaced by qualified service staff only.

To ensure that the battery will be treated properly, hand over the product at end-of-life to the applicable collection point for the recycling of electrical and electronic equipment.

For all other batteries, please view the section on how to remove the battery from the product safely. Hand the battery over to the applicable collection point for the recycling of waste batteries.

For more detailed information about recycling of this product or battery, please contact your local Civic Office, your household waste disposal service or the shop where you purchased the product.

Notice for the customers: the following information is only applicable to equipment sold in the countries applying EU directives

The manufacturer of this product is Sony Corporation, 1-7-1 Konan Minato-ku Tokyo, 108-0075 Japan. The Authorized Representative for EMC and product safety is Sony Deutschland GmbH, Hedelfinger Strasse 61, 70327 Stuttgart, Germany. For any service or guarantee matters please refer to the addresses given in separate service or guarantee documents.

To prevent possible hearing damage, do not listen at high volume levels for long periods.



Notice for users

All rights reserved. This manual or the software described herein, in whole or in part, may not be reproduced, translated or reduced to any machine readable form without prior written approval from Sony Corporation.

IN NO EVENT SHALL SONY CORPORATION BE LIABLE FOR ANY INCIDENTAL, CONSEQUENTIAL OR SPECIAL DAMAGES, WHETHER BASED ON TORT, CONTRACT, OR OTHERWISE, ARISING OUT OF OR IN CONNECTION WITH THIS MANUAL, THE SOFTWARE OR OTHER INFORMATION CONTAINED HEREIN OR THE USE THEREOF.

Sony Corporation reserves the right to make any modification to this manual or the information contained herein at any time without notice.

- The software described herein may also be governed by the terms of a separate user license agreement.
- This software is for Windows and cannot be used for Macintosh.
- The supplied connection support cable is for the IC recorder ICD-UX522/UX522F/UX523/UX523F. You cannot connect other IC recorders.
- Display windows in this manual may differ from what are actually displayed on your IC recorder depending on the area you purchased the IC recorder and the settings you have made.

What you record is for personal enjoyment and use only. Copyright laws prohibit other forms of use without the permission of the copyright holders.

Checking the Parts and Controls

Front

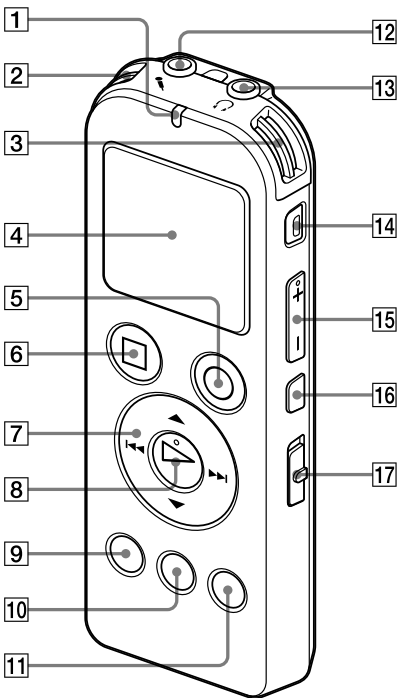

- 1** Operation indicator
- 2** Built-in microphones (stereo) (L)
- 3** Built-in microphones (stereo) (R)
- 4** Display window
- 5** ● REC (record)/PAUSE button
- 6** ■ STOP button
- 7** Control button (▲, ▼ / |◀◀ (review/fast backward), ▶▶| (cue/fast forward))

- 8** ► (play)/ENTER button*
- 9** MENU button
- 10** FOLDER button
- 11** T-MARK (Track mark) button
- 12** 🎤 (microphone) jack*
- 13** 🎧 (headphone) jack
- 14** ERASE button
- 15** VOL (volume) -/+* button
- 16** ↺ (repeat) A-B button
- 17** NOISE CUT switch

* These buttons and the jack have a tactile dot. Use it as a reference point for operations, or to identify each terminal.

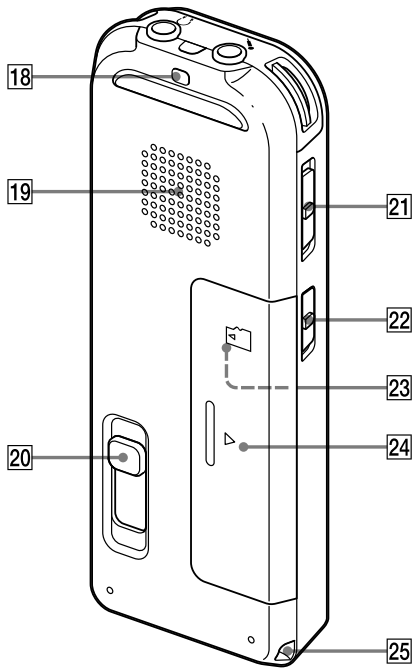
Rear**18 Strap hole**

(A strap is not supplied.)

19 Speaker**20 USB DIRECT slide lever****21 HOLD-POWER switch****22 DPC(SPEED CTRL) switch****23 microSD memory card slot**

(The card slot is in the battery compartment.)

24 Battery compartment**25 Strap hole**

(A strap is not supplied.)

Using the Display Window

Display when stopped

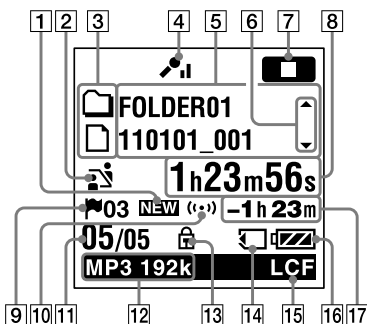

Note

The above window and the other windows in this section display indications, numbers, or items for explanatory purposes. The actual windows may differ from those displayed here.

1 Newly arriving podcast indication

2 Scene select indication

Displays the currently selected scene used for recording. Appears when a scene is set.

- Meeting
- Voice Notes
- Interview
- Lecture
- Audio IN
- My Scene

3 File information type indicator

- A folder where you can record a file
- A folder for playback only
- A folder for podcast files
- Title name
- Artist name
- File name

4 Microphone sensitivity indicator

- High
- Medium
- Low

5 File information

Displays the information for each file according to the file information type (folder name, title name, artist name, file name).

6 Operating guide for switching file information

You can switch the file information display in sequence by pressing ▲ or ▼.

7 Operation mode indicator

Displays the following, depending on the current operation of the IC recorder.

- stop
 - playback
 - REC: recording
 - REC: recording pause (flashing)
 - VOR REC: recording with the VOR function
 - VOR REC: recording pause with the VOR function (flashing)
- If you press ● REC/PAUSE to pause recording when “VOR” is set to “ON” in the menu, only “REC” flashes.
- SYNC REC: synchronized recording
 - SYNC REC: synchronized recording pause (flashing)
 - ◀▶: review/fast backward, cue/fast forward
 - ◀▶: going backward/forward continuously

8 Elapsed time/Remaining time/Recording date and time indication

9 Track mark indicator

Displays the track mark number just before the current position. Appears when a track mark is set for a file.

10 Alarm indicator

Appears when the alarm is set in a file.

11 File number

The selected file number is displayed in the numerator and the total number of files in the folder is displayed in the denominator.

12 Recording mode indicator

Displays the recording mode set using the menu when the IC recorder is in the stop mode or recording mode, and displays the recording mode of the current file when the IC recorder is in the playback mode.

LPCM 44/16 : LPCM file recorded or transferred with the IC recorder

MP3 8k , **MP3 48k** , **MP3 160k** , **MP3 128k** ,

MP3 192k : MP3 file recorded or transferred with the IC recorder

When the files are transferred from your computer, file formats only (**LPCM/MP3**) are displayed.

WMA : WMA files transferred

AAC : AAC-LC files transferred

Displays as follows when the IC recorder cannot get the recording mode.

---- : Unknown

13 Protect indicator

Appears when the protection is set for a file.

14 Memory card indication

Appears when “Memory Card” is selected as “Select Memory.” When “Built-In Memory” is selected, no indication is displayed.

15 LCF (Low Cut Filter) indicator

Appears when “LCF(Low Cut)” is set to “ON” in the menu.

16 Battery indicator

17 Remaining recording time

Displays the remaining recording time in hours, minutes, and seconds. If there is more than 10 hours time remaining, the time is displayed in hours.

If there is more than 10 minutes and less than 10 hours time remaining, the time is displayed in hours and minutes.

If there is less than 10 minutes time remaining, the time is displayed in minutes and seconds.

Display when recording

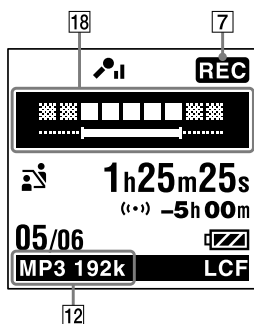

18 Recording level guide display

Displays the recording level and the optimum level for recording.

Display during playback

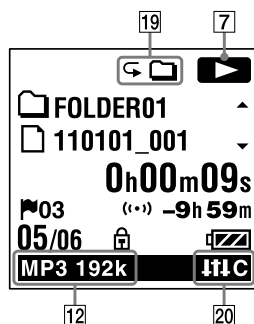

19 Playback mode indicator

1: Appears when a file is played back.

📁 : Appears when files in one folder are played back continuously.

ALL: Appears when all the files are played back continuously.

↺ 1: Appears when one file is played back repeatedly.

↺ 📁 : Appears when files in one folder are played back repeatedly.

↺ ALL: Appears when all the files are played back repeatedly.

20 Noise cut/Effect indicator

Appears when the NOISE CUT switch is set to "ON," or "Effect" is set in the menu.

N-CUT : Noise cut

POP : Pop

ROCK : Rock

JAZZ : Jazz

BA1 : Bass1

BA2 : Bass2

LTC : Custom

Display when listening to an FM radio broadcast

(for ICD-UX522F/UX523F only)

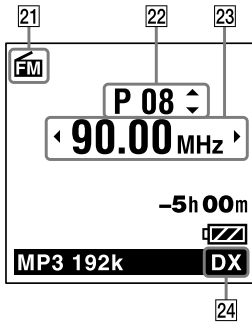

21 FM indicator

22 Preset number

23 Radio frequency

24 Receiver sensitivity

LOCAL : LOCAL

DX : DX

Display when recording an FM radio broadcast

(for ICD-UX522F/UX523F only)

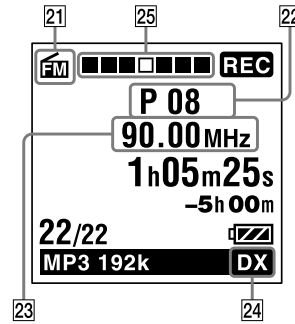

25 Recording progress animation display

Displays the progress of an FM radio recording in animation.

Display in the HOLD status

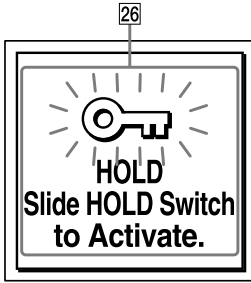

26 HOLD indicator

Appears when the IC recorder is in the HOLD status to prevent unintentional operations.

To release the HOLD status, slide the HOLD•POWER switch towards the center (☞ p. 16).

Display of the current date and time

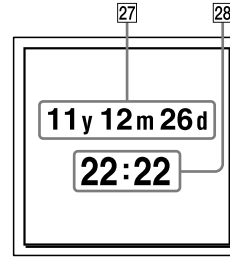

27 Current date display

Displays the current date (year, month, and day) for 3 seconds when you press ■ STOP in the stop mode.
e.g.: 11y01m01d (January 1, 2011)

28 Current time display

Displays the current time (hour and minutes) for 3 seconds when you press ■ STOP in the stop mode.
e.g.: 12:00 (24-Hour time display)/12:00 PM (12-Hour time display)

Display during FOLDER selection

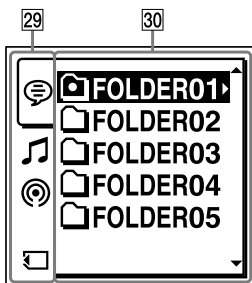

29 Tabs

Displays the types (recordable or playback-only) of areas and memory available:

- ☎ (Voice): Recordable area used to manage files recorded with the IC recorder.
- ♪ (Music): Playback-only area used to manage music files transferred from your computer.
- ☎ (Podcast): Playback-only area used to manage podcast files transferred from your computer.
- 💻 (Built-in memory) : Appears when you insert a memory card and set the memory to the built-in memory.
- 💻 (Memory card) : Appears when you insert a memory card and set the memory to the memory card.

30 Folders

Displays the folders contained in the selected tab.

Display during MENU operation

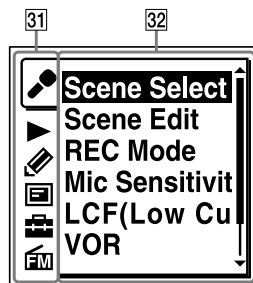

31 Menu tabs

Displays the menu tabs:

- ☎ : Recording
- ▶ : Playback
- ✍ : Edit
- 📺 : Display
- 🧰 : IC recorder settings
- 📻 : FM radio (for ICD-UX522F/UX523F only)

32 Menu items

Displays the menu items of the selected menu tab.

Preventing Unintentional Operations (HOLD)

You can disable all the buttons (HOLD) in order to prevent unintentional operations when you carry the IC recorder, etc.

To disable the button operations (HOLD status)

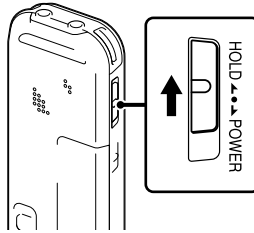

Slide the HOLD•POWER switch in the direction of “HOLD” to disable the buttons while the power is on.

“HOLD” will appear for approximately 3 seconds, indicating that all the button operations are disabled.

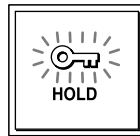

To enable the button operations

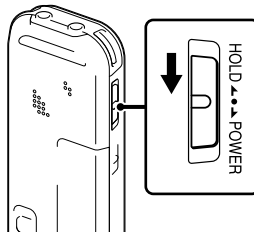

Slide the HOLD•POWER switch towards the center.

Note

When the HOLD function is activated during recording, all the button operations are disabled. To stop recording, cancel the HOLD function first.

Hint

Even if the HOLD function is activated, you can stop the alarm playback by pressing any button. (You cannot stop normal playback.)

Maintaining the Moderate Volume Level (AVLS) (For European models only)

The AVLS (Automatic Volume Limiter System) function allows you to listen to the sound at a moderate volume level when using the headphones. The AVLS function limits the maximum volume to prevent auditory issues or distraction and also to maintain a moderate volume level.

When “AVLS” is set to “ON”

When you try to adjust the volume to a level that exceeds the AVLS-specified level, the “AVLS” indicator lights. You cannot adjust the volume to a level that exceeds the limit.

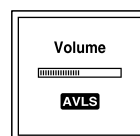

Note

“AVLS” is set to “ON” when you purchase the IC recorder. If you want to turn off the function and play back files at the original volume, use the menu to set “AVLS” to “OFF”.

When “AVLS” is set to “OFF”

To disable the AVLS function, do the following:

- 1 In the stop or playback mode, select MENU → the ▶ tab → “AVLS,” and then press ▶/ENTER.
- 2 Press ▲ or ▼ to select “OFF,” and then press ▶/ENTER.
The “AVLS OFF?” message is displayed with a beeping sound.
- 3 Press ▲ or ▼ to select “Yes,” and then press ▶/ENTER.
- 4 Press ■ STOP to exit the menu mode.

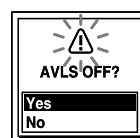

To enable the AVLS function:

Select “ON” in the step 2, or select “No” in the step 3.

If you play back files at a volume that exceeds the AVLS-specified level for specified period of time, the following animation will be displayed and “AVLS” in the menu is automatically set to “ON.”

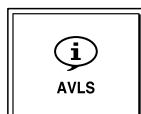

Recharging the Battery

Recharging the battery using a computer

1 Insert a rechargeable battery.

Slide and lift the battery compartment lid, insert an NH-AAA rechargeable battery with correct polarity, and close the lid.



2 Connect the IC recorder to your computer.

Slide the USB DIRECT slide lever on the back of the IC recorder in the direction of the arrow, and insert the USB connector into the USB port of a running computer.*1

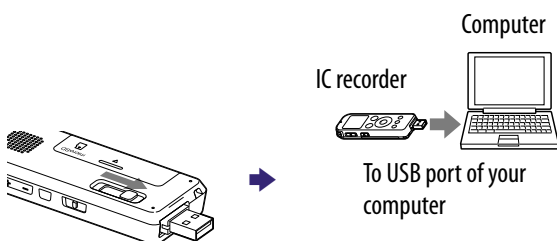

While the battery is charging, “Connecting” and the battery indicator are displayed in an animation.

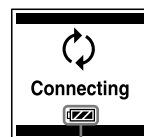

Battery indicator

When the battery is fully charged, the battery indicator will indicate “FULL.” It takes about 3 hours and 30 minutes to fully charge an exhausted battery.*2

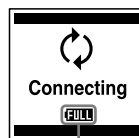

Fully charged indicator

*1 If the IC recorder cannot be connected to a computer directly, use the supplied USB connection support cable.

*2 This is an approximation for the time it takes to charge from no remaining battery power to full battery power at room temperature. It varies depending on the remaining power and the condition of the battery. It also takes more time if the temperature of the battery is low, or if the battery is charged while you are transferring data to the IC recorder.

3 Disconnect the IC recorder from your computer.

Follow the procedures below; otherwise, when the IC recorder contains data files, the files may be damaged or become unplayable.

① Make sure that the operation indicator does not light.

② Perform the following operation on your computer.

On the Windows taskbar at the bottom right of the desktop, left-click the following icon:



▶ Left-click “Eject IC RECORDER” (Windows 7), or “Safely remove USB Mass Storage Device” (Windows XP, Windows Vista).

The icon and menu displayed can be different on different operating systems. The icon may not be always displayed on the taskbar depending on your computer settings.

On a Macintosh screen, drag “IC RECORDER” on the Finder to “Trash” and drop it there.

For details on disconnecting the IC recorder from your computer, refer to the operating instructions supplied with your computer.

③ Disconnect the IC recorder from the USB port of the computer, and slide the USB DIRECT slide lever in the direction of the arrow to retract the USB connector.

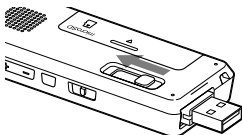

When using a fully charged battery or an LR03 (size AAA) alkaline battery

Follow the step ①.

Recharging the battery using a USB AC adaptor

You can also charge the battery by using a USB AC adaptor (not supplied) (☞ p. 111).

Inserting a Memory Card

In addition to the built-in memory, you can record files on a memory card.

Inserting a memory card

- 1 Slide and lift the battery compartment lid, while the IC recorder is turned off or in the stop mode.**

The memory card slot is within the battery compartment.

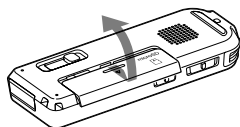

- 2 Insert a microSD card into the memory card slot in the battery compartment with the label side facing up, until it clicks into place.**

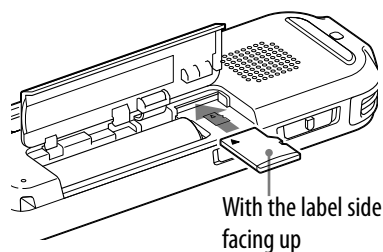

- 3 Close the battery compartment lid.**

To remove a memory card

Push the memory card into the slot. When it pops out, remove it from the memory card slot.

Structure of folders and files

5 folders are created in a memory card in addition to those in the built-in memory. The structure of folders and files is somewhat different from that of the built-in memory (📖 p. 97).

Notes

- If a memory card is not recognized, remove it and then insert it into the IC recorder again.
- Do not insert any liquid, metal, flammable or any object other than a memory card into the memory card slot. Doing so may cause fire, electric shock, or malfunctions.
- Before recording, we recommend that you copy all the data stored on the memory card to your computer and format the memory card on the IC recorder so it contains no data.

About compatible memory cards

You can use microSD/MicroSDHC memory cards with the IC recorder. However, a memory card of 64 MB or less is not supported.

Due to the file system specifications of the IC recorder, you can record and play back an LPCM file smaller than 2 GB, and an MP3/WMA/AAC-LC file smaller than 1 GB using a memory card.

Note

Operations of all types of compatible memory cards are not guaranteed.

Turning the IC Recorder On

Turning the power on

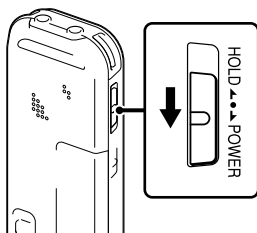

Slide and hold the HOLD•POWER switch in the direction of “POWER” until the window display appears. The IC recorder is turned on.

Turning the power off

Slide and hold the HOLD•POWER switch in the direction of “POWER” until the “Power Off” animation is displayed. The IC recorder is turned off.

Hint

When the IC recorder is in the stop mode, and you leave the IC recorder without attempting an operation for a certain length of time, the auto power off function will take effect. (The length of time before auto power off is set to “10min” when you purchase the IC recorder.)

Setting the Clock

You need to set the clock to use the alarm function or record the date and time.

Setting the clock after recharging the battery

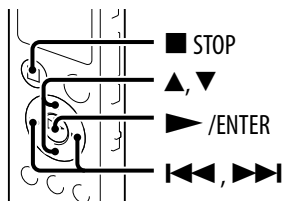

When you insert a battery for the first time, or when you insert a battery after the IC recorder has been without a battery for more than 1 minute, the “Set Date&Time” animation appears, and then the year section begins to flash in the clock setting display window.

1 Set year, month, day, hour and minute.

Press ▲ or ▼ to set the year (the last two digits of the year), and then press ► /ENTER. Repeat this procedure to set month, day, hour, and minute in sequence.

You can move the cursor to the year, month, day, hour and minute by pressing ◀◀ and ▶▶.

When you set the minute and press ► /ENTER, the clock reflects the setting.

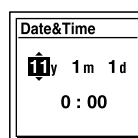

2 Press ■ STOP to return to the stop mode display.

Setting the clock using the menu

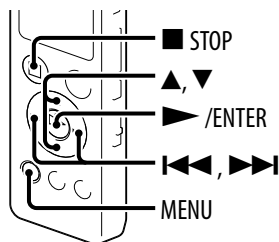

While the IC recorder is in the stop mode, you can set the clock using the menu.

1 Select "Date&Time" in the menu.

① Press MENU to enter the menu mode.

The menu mode window will be displayed.

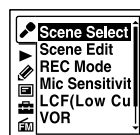

② Press **◀◀**, and then press **▲** or **▼** to select the **📻** tab, and then press **▶** /ENTER.

(The **📻** (FM radio) tab is displayed only on the ICD-UX522F/UX523F.)

③ Press **▲** or **▼** to select "Date&Time," and then press **▶** /ENTER.

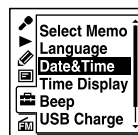

2 Press **▲** or **▼** to select "Auto(Synchronizing)" or "Manual," and then press **▶** /ENTER.

When you select "Auto(Synchronizing)," the clock is automatically adjusted using the clock in the computer connected to the IC recorder and on which the supplied Sound Organizer software is started.

When you select "Manual," proceed to the next steps.

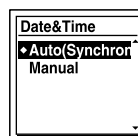

3 Press **▲** or **▼** to select "11y1m1d," and then press **▶** /ENTER.

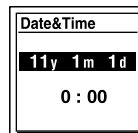

4 Set year, month, day, hour and minute.

Press ▲ or ▼ to set the year (the last two digits of the year), and then press ► /ENTER. Repeat this procedure to set month, day, hour, and minute in sequence.

You can move the cursor to the year, month, day, hour and minute by pressing ◀◀ and ▶▶.

When you set the minute and press ► /ENTER, the clock reflects the setting.

5 Press ■ STOP to return to the stop mode display.

Notes

- If you do not press ► /ENTER within 1 minute of entering the clock setting data, the clock setting mode is canceled and the window will return to the display of the stop mode.
- The time is displayed either in 12-Hour with “AM” or “PM,” or in 24-Hour, depending on the “Time Display” setting in the menu. The default setting differs depending on the country or region you purchased the IC recorder.

To display the current date and time

While the IC recorder is in the stop mode, press ■ STOP to display the current date and time for about 3 seconds.

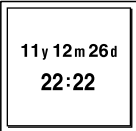

11y 12m 26d
22:22



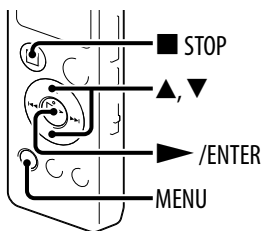

Setting the Language to Be Used in the Display Window

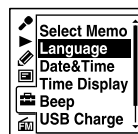

You can select the language to be used for messages, menus, folder names, file names, etc.

- 1 Select **MENU** → the  tab → “Language,” and then press  /ENTER.



- 2 Press  or  to select the language that you want to use, and then press  /ENTER.
- 3 Press  **STOP** to return to the stop mode display.

Selecting a Folder, File, Tab, and Memory

Selecting a folder and a file

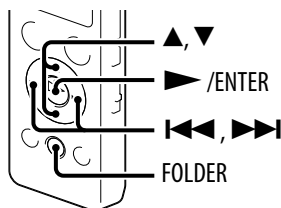

You can select a folder and a file for recording, playing or editing as follows:

1 Press FOLDER .

The folder selection window is displayed.

2 Select a folder.

Press ▲ or ▼ to select the desired folder, and then press ► /ENTER.

To display the files contained in the selected folder, press ►►.

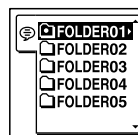

When you purchase the IC recorder, there are 5 folders already available (FOLDER01-05).

3 Select a file.

When the file selection window is displayed, press ▲ or ▼ to select the desired file, and then press ► /ENTER.

When the stop mode window is displayed, you can switch files by pressing ◀◀ and ▶▶.

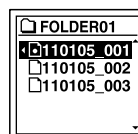

Selecting a tab

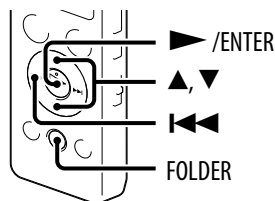

The recordable area and the playback-only area of folders stored on the IC recorder are managed separately, and are displayed with tabs. You can select a tab as follows:

1 Press FOLDER.

The folder selection window is displayed.

2 Press ◀◀, and then press ▲ or ▼ to select the ☎, 🎵, or 📁 tab.

Only the ☎ tab will be displayed when you purchase the IC recorder.

The 🎵 tab and the 📁 tab will be displayed when you transfer files from your computer (👉 p. 102, 105).

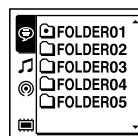

3 Press the ▶ /ENTER.

The folders contained in the selected tab are displayed.

4 Select a folder and a file (👉 p. 27).

Selecting the memory

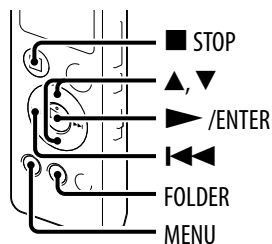

You can switch the memory between the built-in memory and a memory card by using the folder selection window or using the menu:

Selecting the memory using the folder selection window

1 Press FOLDER .

The folder selection window is displayed.

2 Press , and then press or to select the or tab.

(Built-in memory) or (memory card) tab will appear when you insert a memory card into the IC recorder (p. 20).

3 Press the /ENTER.

The memory selection window is displayed.

4 Press or to select “Built-in Memory” or “Memory Card,” and then press /ENTER.

The tab icon is changed to those of the selected memory, or .

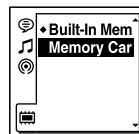

5 Press STOP to return to the stop mode display.

Selecting the memory using the menu

- 1 Select MENU → the  tab → "Select Memory," and then press  /ENTER.

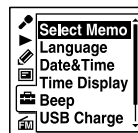

- 2 Press ▲ or ▼ to select "Memory Card" or "Built-in Memory," and then press  /ENTER.

If you select "Memory Card" and the memory card has not been formatted, proceed to the next step.

Otherwise, proceed to step 5.

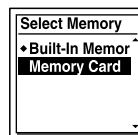

- 3 When the memory card is not formatted, select Menu → the  tab → "Format," and then press  /ENTER.

"Erase All Data?" will be displayed.

- 4 Press ▲ or ▼ to select "Execute," and then press  /ENTER.

The memory card is formatted.

- 5 Press ■ STOP to return to the stop mode display.

Basic Recording

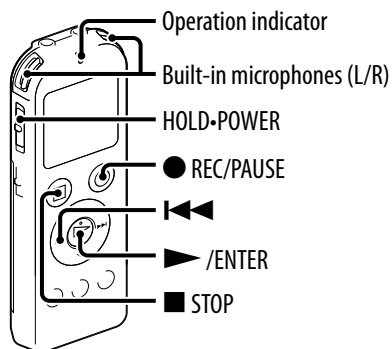

The following are the basic recording procedures using the specified microphone sensitivity and recording mode.

Note

Noise may be recorded if an object, such as your finger, etc., accidentally rubs or scratches the IC recorder during recording.

Hint

Before you start recording, we recommend you make a trial recording first, or monitor the recording (☞ p. 32).

- 1 Slide the **HOLD•POWER** switch in the direction of **“POWER”** to turn on the IC recorder (☞ p. 22), or towards the center to release the IC recorder from the **HOLD** status (☞ p. 16).

The stop mode window appears.

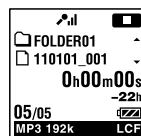

- 2 Select the desired folder (☞ p.27).

- 3 Place the IC recorder so that the built-in microphones face the direction of the source to be recorded.



4 Press ● REC/PAUSE in the stop mode.

The operation indicator lights in red.

You do not need to press and hold ● REC/PAUSE while recording.

The new file will be automatically recorded as the last file in the current folder.

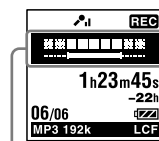

Recording level guide

About the recording level guide

During recording, the recording level guide is displayed.

The upper meter shows the current input level. The white bar in the lower meter shows the optimum input level for recording.





Please adjust the orientation of the built-in microphones, the distance from the sound source, the microphone sensitivity, or the scene select setting so that the upper input level fits within the lower optimum range, as illustrated above.

Hint

If the white portion of the input level meter is short, we recommend that you place the IC recorder nearer to the sound source or set the microphone sensitivity higher.

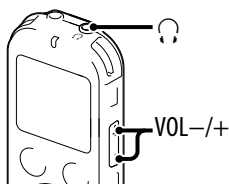
Monitoring the recording



If you connect the supplied stereo headphones to the  (headphone) jack, you can monitor the recording. You can adjust the monitoring volume by pressing VOL -/+, but the recording level is fixed.

Stopping the recording

1 Press ■ STOP.

The “Accessing...” animation appears and the IC recorder stops at the beginning of the current recording file.

Note while accessing

The IC recorder is recording data and storing it on the memory media when the “Accessing...” animation appears on the display. While the IC recorder is accessing data, do not remove the battery or connect or disconnect the USB AC adaptor (not supplied). Doing so may damage the data.

Other operations

To	Do this
pause recording*	Press ● REC/PAUSE. During recording pause, the operation indicator flashes in red and “  ” begins to flash in the display window.
release pause and resume recording	Press ● REC/PAUSE again. Recording resumes from that point. (To stop recording after pausing recording, press ■ STOP.)
review the current recording instantly	Press ►/ENTER. Recording stops and playback starts from the beginning of the file just recorded.
review during recording	Press and hold ◀◀ during recording or recording pause. Recording stops and you can search backwards while listening to fast playback sound. After you release ◀◀, playback starts from that point.

* 1 hour after you pause recording, recording pause is automatically released and the IC recorder enters the stop mode.

Hint

You can make new folders or erase unwanted folders using the supplied Sound Organizer software (🔗 p. 105).

Changing the Recording Settings

Selecting a recording scene for each situation

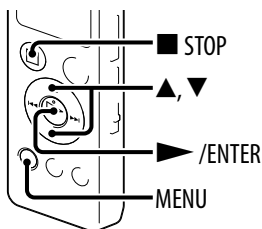

According to various recording scene, you can change the items for recording, such as REC Mode (🔊 p. 82), Mic Sensitivity (🔊 p. 82), etc., to the recommended settings in bulk. You can change the settings for each item.

- 1 In the stop mode, select MENU → the 🔊 tab → “Scene Select,” and then press ► /ENTER.**



- 2 Press ▲ or ▼ to select a scene you want, and then press ► /ENTER.**
- 3 Press ■ STOP to exit the menu mode.**

Scenes	Descriptions
🗣️ (Meeting)	To record in a variety of situations, such as recording in a spacious conference room.
💬 (Voice Notes)	To record dictation with a microphone in front of your mouth.
🗣️ (Interview)	To record human voice at a distance of 1 to 2 meters (40 to 80 in.).
🗣️ (Lecture)	To record a wide range of sound, such as a lecture in a classroom or a chorus lesson.
🔊 (Audio IN)	To record from external equipment, such as a television, portable CD/MD player or a tape recorder, connected to the IC recorder via an audio output connector (stereo mini-jack) with an audio connecting cable for dubbing.
📌 (My Scene)	Use to keep your favorite settings.

Tips for better recording

There are ways of making better recordings other than using scene selection.

Recording at a meeting

By placing the IC recorder on a handkerchief, etc. substituting for a stand, you can record with clear, low-noise sound, without vibration noise from the desk.



Recording a voice note

By placing the IC recorder close to one side of your mouth, you can prevent breathing on the built-in microphones, and record with clear sound.



Recording an interview

Place the IC recorder so that the built-in microphones face the interviewee.



Recording a music performance

By attaching a tripod (not supplied) or placing the recorder on a stand or table, you can adjust the angle of the IC recorder and the built-in microphones more precisely.

When recording a chorus or piano performance, for example, place the IC recorder on a table approximately 2 to 3 meters (80 to 120 in.) from the performer(s). Set up the IC recorder with the display window facing up, and with the built-in microphones pointing towards the sound source.













Changing the Scene Select settings

- 1 In the stop mode, select MENU → the  tab → “Scene Edit,” and then press ►/ENTER.















- 2 Press ▲ or ▼ to select the scene you want to change the settings, and then press ►/ENTER.
- 3 Press ▲ or ▼ to select “Edit from Current Setting” or “Edit,” and then press ►/ENTER.
- 4 Press ▲ or ▼ to select the item you want to change, and then press ►/ENTER.
- 5 Press ▲ or ▼ to select a setting item, and then press ►/ENTER.
For details on the menu items and settings, see “Making Settings for the Menu.” (📖 p. 81 – 83)
- 6 Press ▲ or ▼ to select “Edit Complete,” and then press ►/ENTER.
- 7 Press ■ STOP to exit the menu mode.

Changing the Scene Select setting to the default values

- 1 In the stop mode, select MENU → the  tab → “Scene Edit,” and then press /ENTER.
- 2 Press  or  to select the scene you want to change the settings to the default values, and then press /ENTER.
- 3 Select “Set Default Value,” and then press /ENTER.
“Default Value?” will be displayed.
- 4 Press  or  to select “Execute,” and then press /ENTER.
The menu item settings of the selected scene will be set to the default values.
- 5 Press  STOP to exit the menu mode.

Default settings

For details on the menu items and settings, see pages 81 through 83.

	 (Meeting)	 (Voice Notes)	 (Interview)	 (Lecture)	 (Audio IN)	 (My Scene)
REC Mode	MP3 192kbps	MP3 128kbps	MP3 192kbps	MP3 192kbps	MP3 192kbps	MP3 192kbps
Mic Sensitivity	 Medium	 Low	 Medium	 Medium	 Low	 Medium
LCF(Low Cut)	ON	ON	ON	OFF	OFF	OFF
VOR	OFF	OFF	OFF	OFF	OFF	OFF
SYNC REC	OFF	OFF	OFF	OFF	ON	OFF
Select Input	MIC IN	MIC IN	MIC IN	MIC IN	Audio IN	MIC IN

Starting to Record Automatically in Response to Sound – the VOR Function

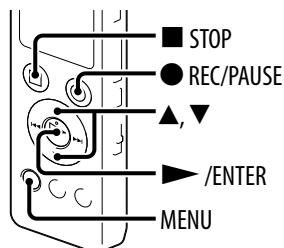

You can set the VOR (Voice Operated Recording) function to “ON,” to make the IC recorder start recording when the IC recorder detects sound, and pause when no sound is heard, eliminating recording during soundless periods.

- 1 In the stop or recording mode, select **MENU** → the **tab** → “VOR,” and then press **▶/ENTER**.

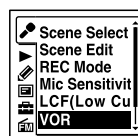

- 2 Press **▲** or **▼** to select “ON,” and then press **▶/ENTER**.
“VOR” is set to “OFF” when you purchase the IC recorder.

- 3 Press **■ STOP** to exit the menu mode.

- 4 Press **● REC/PAUSE**.

“VOR^{REC}” appears in the display window.

The recording pauses when no sound is detected and “VOR^{OFF}” flashes.
When the IC recorder detects sound again, the recording starts again.

To cancel the VOR function

Set “VOR” to “OFF” in step 2.

Notes

- The VOR function is affected by the sound around you. Set “Mic Sensitivity” in the menu according to the recording conditions. If recording is not satisfactory after you have changed the “Mic Sensitivity” setting, or for an important recording, set “VOR” to “OFF” in the menu.
- During synchronized recording (☞ p. 40) and the FM recording (☞ p. 71) (for ICD-UX522F/UX523F only), the VOR function does not work.

Recording via Other Devices

Recording with an external microphone

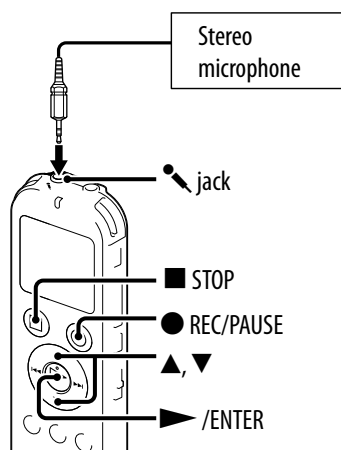

- 1 Connect an external microphone to the jack when the IC recorder is in the stop mode.**

“Select Input” appears in the display window.

If “Select Input” is not displayed, set it in the menu (☞ p. 83).

- 2 Press ▲ or ▼ to select “MIC IN,” and then press ►/ENTER.**

- 3 Press ■ STOP to exit the menu mode.**

- 4 Press ● REC/PAUSE to start recording.**

The built-in microphones are automatically cut off.

If the input level is not strong enough, adjust the “Mic Sensitivity” setting on the IC recorder.

When a plug in power type microphone is connected, power is automatically supplied to the microphone from the IC recorder.

To record sound from a telephone or a cell phone

You can use a headphone-type electret condenser microphone to record sound from a telephone or a cell phone.

For details on how to make the connection, refer to the operating instructions supplied with the microphone.

Recording from other equipment

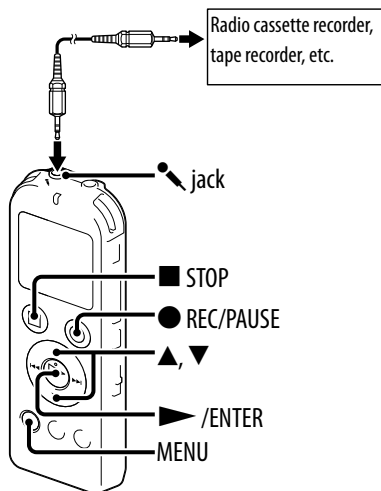

You can make music files without using the computer by recording sound/music from other equipment such as a radio cassette recorder, a tape recorder, etc. connected to the IC recorder.

When you select “Audio IN” from the “Scene Select” menu, the settings suitable for recording from other equipment are already selected (☞ p. 34).

Hint





If the input level is not strong enough, connect the headphone jack (minijack, stereo) of other equipment to the  jack of the IC recorder and adjust the volume level on the piece of equipment connected to the IC recorder while checking the recording level guide.

To record using the synchronized recording function

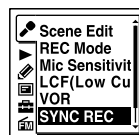
The IC recorder pauses when no sound is detected for more than 2 seconds. The IC recorder starts recording again as a new file when sound is detected.

- 1 Select MENU → the  tab → “SYNC REC,” and then press  /ENTER.



- 2 Press  or  to select “ON,” and then press  /ENTER.
- 3 Press  STOP to exit the menu mode.

4 Connect other equipment to the IC recorder when the IC recorder is in the stop mode.

Connect the audio output connector (stereo mini-plug) of other equipment to the  jack of the IC recorder using an audio connecting cable.

“Select Input” appears in the display window.

If “Select Input” is not displayed, set it in the menu ( p. 83).

5 Press ▲ or ▼ to select “Audio IN,” and then press ►/ENTER.

6 Press ● REC/PAUSE to start recording.

“SYNC  ” flashes and the IC recorder enters the recording pause mode.

7 Start playback on the piece of equipment connected to the IC recorder.

“SYNC  ” appears on the display and synchronized recording starts.

When no sound is detected for more than 2 seconds, “Dividing...” appears and then “SYNC  ” begins to flash. The synchronized recording pauses.

The IC recorder starts recording again as a new file when sound is detected.

To record without using the synchronized recording function

Select “OFF” in step **2** of “To record using the synchronized recording function” ( p. 40), and then proceed with steps **3** through **7**. When you press ● REC/PAUSE in step **6**, the built-in microphones are automatically cut off and the sound from the connected piece of equipment is recorded.

Basic Playback

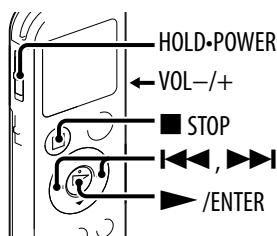

- 1 Slide the **HOLD-POWER** switch in the direction of “POWER” to turn on the IC recorder (☞ p. 22), or towards the center to release the IC recorder from the HOLD status (☞ p. 16).

The stop mode window appears.

- 2 Select the desired file to be played back (☞ p.27).

If you do not select a file, the file just recorded will be played back.

- 3 Press ► /ENTER.

Playback starts, and the operation indicator will light in green.

- 4 Press VOL -/+ to adjust the volume.

Note for the customers in Europe

When “AVLS” is set to “ON” in the menu and the “AVLS” indicator is displayed, you cannot adjust the volume to a level that exceeds the AVLS-specified level. If you want to turn off the function and play back files at the original volume, use the menu to set “AVLS” to “OFF”

Stopping playback

- 1 Press ■ STOP.

Other operations

To	Do this
stop at the current position (Playback Pause function)	Press ►/ENTER. To resume playback from that point, press ►/ENTER again.
go back to the beginning of the current file	Press ◀◀ once.*1*2
go back to previous files	Press ◀◀ repeatedly. (During the stop mode, keep the button pressed to go back the files continuously.*3)
skip to the next file	Press ▶▶ once.*1*2
skip to the succeeding files	Press ▶▶ repeatedly. (During the stop mode, keep the button pressed to skip the files continuously.*3)

*1 When a track mark is set, the IC recorder goes backward or forward to the track mark before or after the current point (☞ p. 61).

*2 These operations are for when “Easy Search” is set to “OFF” (☞ p. 51).

*3 In the continuous searching mode, the IC recorder does not locate track marks.

Display when playing back a file

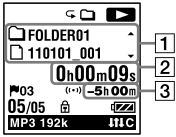

1 File information

Press ▲ or ▼ to check the file information during playback.
A file recorded using the IC recorder is displayed as follows.



📁 : Folder name: FOLDER01-FOLDER05

📄 : File name: Date_file number (e.g. 110101_001)



👤 : Artist name (e.g. My Recording)

🎵 : Title: Date_file number (e.g. 110101_001)

2 Counter information

You can select the display mode in the menu (ⓘ p. 88).

Elapsed time: The elapsed playback time of one file

Remaining time: The remaining playback time of one file

Recording date: Date recorded

Recording time: Time recorded

3 Remaining recording time

Displays the remaining recording time in hours, minutes, and seconds.

If there is more than 10 hours time remaining, the time is displayed in hours.

If there is more than 10 minutes and less than 10 hours time remaining, the time is displayed in hours and minutes.

If there is less than 10 minutes time remaining, the time is displayed in minutes and seconds.

Changing the Playback Settings

Reducing noise in the playback sound and making the human voice clearer – the noise cut function

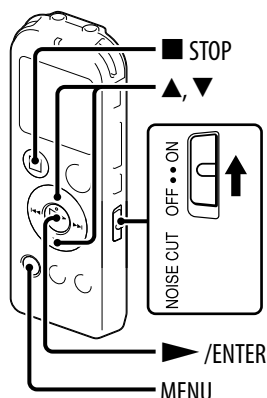

When you set the NOISE CUT switch to “ON,” ambient noise other than the human voice is reduced. A file is played back with clear sound quality because the noise of all frequency bands including a human voice is reduced.

To set the noise cut level

- 1 In the stop or playback mode, select **MENU** → the **▶** tab → “Noise Cut Level,” and then press **▶** /ENTER.

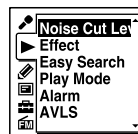

- 2 Press **▲** or **▼** to select “Maximum” or “Medium,” and then press **▶** /ENTER.

- 3 Press **■** STOP to exit the menu mode.

To cancel the noise cut function

Set the NOISE CUT switch to “OFF.”

Note

When playing back a music file in good sound quality, make sure to set the NOISE CUT switch to “OFF.”

Adjusting the playback speed – the DPC (Digital Pitch Control) function

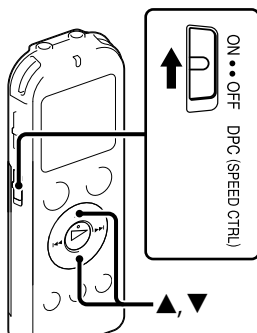

You can adjust the playback speed in a range from 0.50 times to 2.00 times. The file is played back in natural tones by means of a digital processing function.

- 1 Slide the DPC(SPEED CTRL) switch to "ON."**
- 2 During playback, press ▲ or ▼ to adjust the playback speed.**

The speed decreases by 0.05 times (from $\times 0.50$ to $\times 1.00$).

The speed increases by 0.10 times (from $\times 1.00$ to $\times 2.00$).

When you press and hold each button, you can change the speed continuously.

The playback speed is set to " $\times 0.70$ " when you purchase the IC recorder.

To resume normal playback speed

Slide the DPC(SPEED CTRL) switch to "OFF"

Note

You cannot play back an LPCM file at a speed exceeding 1.00 times the recorded speed. If you attempt to adjust the playback speed faster than that limit, "NO FAST" appears in the display window.

Selecting the sound effect

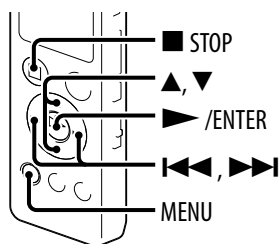

You can set the effect you want for the playback in the menu.

- 1 In the stop or playback mode, select MENU → the ▶ tab → “Effect,” and then press ▶/ENTER.

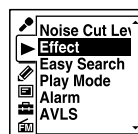

- 2 Press ▲ or ▼ to select effect you want for the playback, and then press ▶/ENTER.
- 3 Press ■ STOP to exit the menu mode.

Option items	Description
Pop	Stresses middle ranges, ideal for vocals.
Rock	Emphasizes high and low ranges for a powerful sound.
Jazz	Emphasizes high ranges for lively sound.
Bass1	Emphasizes the bass sound.
Bass2	Emphasizes the bass sound even more.
Custom	You can design your own custom sound level for 5 bands.
OFF	Disables the effect function.

To set your favorite sound level

- 1 Set "Effect" to "Custom" in step 2 on page 47 , and then press ► / ENTER.

The custom setting window will be displayed.

- 2 When you adjust the sound level for the 100 Hz, 300 Hz, 1 kHz, 3 kHz, and 10 kHz bands, press ◀◀ or ▶▶ to move to the band to the left or right, and then press ▲ or ▼ .

The setting can be adjusted in 7 steps from -3 to +3.

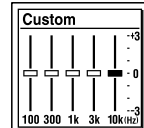

- 3 Press ► / ENTER.
- 4 Press ■ STOP to exit the menu mode.

Selecting the playback mode

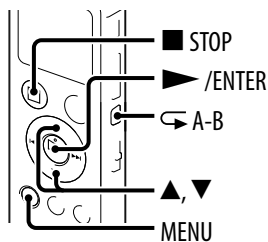

You can select the playback mode in the menu.

- 1 In the stop or playback mode, select **MENU** → the **▶** tab → “Play Mode,” and then press **▶/ENTER**.

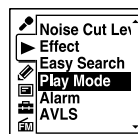

- 2 Press **▲** or **▼** to select “1,” “,” “ALL,” “ 1,” “ ,” or “ ALL,” and then press **▶/ENTER**.
- 3 Press **■ STOP** to exit the menu mode.

Option items	Description/reference page
1	A file is played back.
	Files in one folder are played back continuously.
ALL	All the files are played back continuously.
1	One file is played back repeatedly.
	Files in one folder are played back repeatedly.
ALL	All the files are played back repeatedly.

To play back a specified section repeatedly – A-B repeat

- 1 During playback, press \hookrightarrow A-B to specify the starting point A.**
“A-B B?” is displayed.
 - 2 Press \hookrightarrow A-B again to specify the finishing point B.**
“ \hookrightarrow A-B” is displayed and the specified section is played back repeatedly.
-

To resume normal playback:

Press \blacktriangleright /ENTER.

To stop A-B repeat playback:

Press \blacksquare STOP.

To change the segment specified for A-B repeat playback:

During A-B repeat playback, press \hookrightarrow A-B again to specify a new starting point A. Then specify a new finishing point B, as in step **2**.

Convenient playback methods

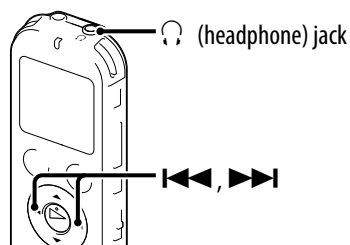

Listening with better sound quality

- To listen with the headphones:
Connect the supplied stereo headphones to the ♯ (headphone) jack. The built-in speaker will be automatically disconnected.
- To listen from an external speaker:
Connect an active or passive speaker to the ♯ (headphone) jack.

Quickly locating the point you wish to start playback (Easy search)

When “Easy Search” is set to “ON” (☞ p. 85) in the menu, you can quickly locate the point at which you wish to start playback by pressing ◀◀ or ▶▶ repeatedly during playback.

You can set the skip time when ◀◀ or ▶▶ is pressed. This function is useful for locating a desired point in a long recording such as at a meeting.

Searching forward/backward during playback (Cue/Review)

- To search forward (Cue):
Press and hold ▶▶ during playback and release it at the point you wish to resume playback.
- To search backward (Review):
Press and hold ◀◀ during playback and release it at the point you wish to resume playback.

The IC recorder searches at slow speed with playback sound. This is useful to check one word forward or back. Then, if you press and hold the button, the IC recorder starts to search at higher speed.

💡 When files are played back or searched to the end of the last file

- When you play back or fast play back to the end of the last file, “FILE END” lights up for approx. 5 seconds.
- When “FILE END” and the operation indicator go off, the IC recorder will stop at the beginning of the last file.
- If you press and hold ◀◀ while “FILE END” is lit, the files are played back rapidly, and normal playback will start at the point you release the button.

Selecting a Recording Date from the Calendar and Playing Back

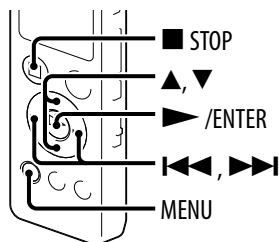

You can play back a file recorded using the IC recorder by searching for it from the calendar.

- 1 In the stop or playback mode, select MENU → the tab → “Calendar,” and then press ►/ENTER.**

The calendar appears after the “Accessing...” animation, and the current date will be selected.

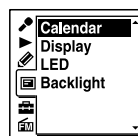

- 2 Press ◀◀ or ▶▶ to select a date, and then press ►/ENTER.**

The underline is displayed at the date where a recorded file exists.



You can move to the previous week or the following week of the date by pressing ▲ or ▼. When you press and hold each button, you can move continuously through the dates or the weeks.

- 3 Press ▲ or ▼ to select a file, and then press ►/ENTER.**

A confirmation message appears, and the file you selected will be played back.

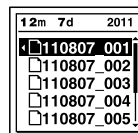

- 4 Press ▲ or ▼ to select “Enter,” and then press ►/ENTER.**

The file will be played back.

- 5 Press ■ STOP to stop playback.**

To cancel the selection of a recording date from the calendar and the accompanying playback

Press ■ STOP before step ④.

Notes

- You need to set the clock in advance to select a recording date from the calendar and play back a file (🔍 p. 23).
- If you specify a date where a recorded file does not exist, “No File” will be displayed. Select a date where a recorded file exists.
- You can search for and play back only the files in the recordable folder that contains files recorded with the IC recorder. For details, see “Structure of folders and files” (🔍 p. 97).

Playing Back a File at a Desired Time with an Alarm

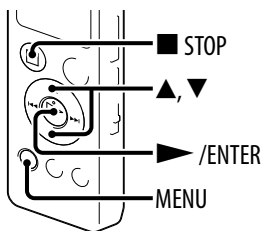

You can sound an alarm and start playback of a selected file at a desired time. You can have a file played back on a specified date, once every week, or at the same time every day. You can set an alarm for a file.

1 Select the file you want to play back with an alarm.

2 Enter the alarm setting mode.

① In the stop mode, select MENU → the ▶ tab → “Alarm,” and then press ▶/ENTER.

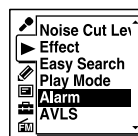

② Press ▲ or ▼ to select “ON,” and then press ▶/ENTER.

3 Set the alarm date and time.

① Press ▲ or ▼ to select “Date,” a day of the week, or “Daily,” and then press ▶/ENTER.

② When you select “Date”:

Set the year, month, day, hour, and minute in sequence, as described in “Setting the Clock” (📖 p. 23).

When you select a day of the week or “Daily”:

Press ▲ or ▼ to set the hour, and then press ▶/ENTER. Press ▲ or ▼ to set the minute, and then press ▶/ENTER.

4 Press ▲ or ▼ to select a favorite alarm pattern, and then press ▶/ENTER.

“Executing...” is displayed.



5 Press ■ STOP to exit the menu mode.

The setting process is finished and “(●)” (alarm indicator) appears in the display window.

To change the alarm setting

Select the file you want to change its alarm setting, and then follow steps ② through ⑤.

To cancel the alarm setting

Follow steps ① and ②. In step ②-② select “OFF” and press ►/ENTER. The alarm will be canceled and the alarm indicator will disappear from the display window.

When the set date and time comes

At the set time, the IC recorder is automatically turned on and “ALARM” is displayed in the display window. Then the alarm and the selected file will be played back using the selected alarm pattern.

When the playback ends, the IC recorder will stop automatically. (When the alarm pattern is set to “Beep&Play” or “Play,” the IC recorder will stop at the beginning of the selected file.)

To stop the alarm playback

Press any button other than VOL -/+ while the alarm sound is heard. If the HOLD function is activated, you can stop the alarm playback by pressing any button.

Playback via Other Devices

Recording with other equipment

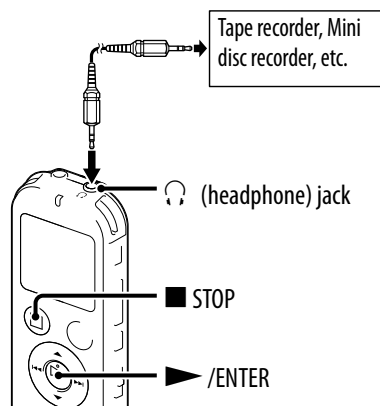

You can record the sound of the IC recorder with other equipment. Before you start recording, we recommend you make a trial recording first.

- 1 Connect the (headphone) jack of the IC recorder to the external input terminal of other equipment using an audio connecting cable.**
- 2 Press ►/ENTER to start playback and at the same time set the connected equipment to the recording mode.**
A file from the IC recorder will be recorded on the equipment connected.
- 3 Press ■ STOP on the IC recorder and the connected equipment at the same time to stop recording.**

Erasing a File

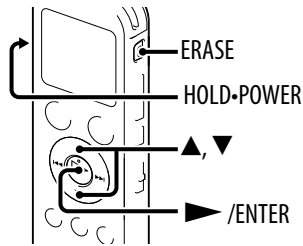

You can select a file and erase it as follows.

Note

Once a file has been erased, you cannot retrieve it.

- 1 **Slide the HOLD•POWER switch in the direction of “POWER” to turn on the IC recorder** (🔗 p. 22), or **towards the center to release the IC recorder from the HOLD status** (🔗 p. 16).

The stop mode window appears.

- 2 **Select the file you want to erase when the IC recorder is in the stop or playback mode** (🔗 p.27).

- 3 **Press ERASE.**

“Erase?” is displayed and the specified file is played back for confirmation.

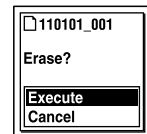

- 4 **Press ▲ or ▼ to select “Execute.”**

- 5 **Press ►/ENTER.**

The “Erasing...” animation appears in the display window and the selected file will be erased.

When a file is erased, the remaining files will advance so that there will be no space between files.

To cancel erasing

Select “Cancel” in step 4, and then press ►/ENTER.

To erase a part of a file

Divide the file into two files first (🔗 p. 64), and then proceed with steps 2 through 5.

Erasing All Files in a Folder

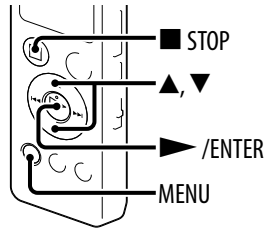

- 1** Select the folder containing the files you want to erase when the IC recorder is in the stop mode (☞ p.27).
- 2** Select MENU → the tab → “Erase All,” and then press ►/ENTER. “Erase All Files in the Folder?” will be displayed.
- 3** Press ▲ or ▼ to select “Execute,” and then press ►/ENTER. The “Erasing...” animation appears in the display window and all files in the selected folder will be erased.
- 4** Press ■ STOP to exit the menu mode.

To cancel erasing

Select “Cancel” in step **3**, and then press ►/ENTER.

Arranging Files in a Folder

Moving a file to a different folder

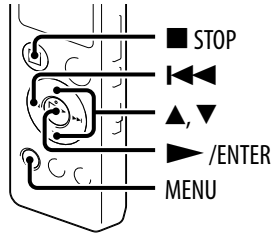

1 Select the file you want to move.

2 In the stop mode, select MENU → the tab → “Move File,” and then press ►/ENTER.

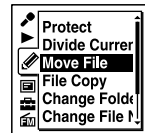

3 Press ◀◀, press ▲ or ▼ to select the tab or the tab, and then press ►/ENTER.

4 Press ▲ or ▼ to select the folder that you want to move the file into, and then press ►/ENTER.

“Moving File...” animation is displayed and the file is moved to the last position in the destination folder.

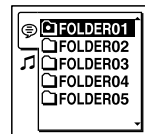

When you move a file to another folder, the original file in the previous folder will be erased.

5 Press ■ STOP to exit the menu mode.

To cancel moving the file

Press ■ STOP before step **4**.

Copying a file to the other memory

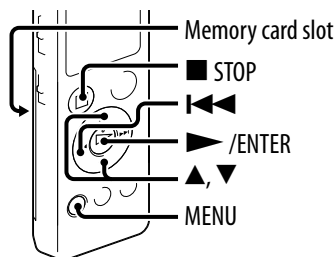

You can copy files between the built-in memory and a memory card, which is useful in saving a backup. Before starting the operation, insert a memory card to be used for copying into the memory card slot.

1 Select the file you want to copy.

When you want to copy a file from a memory card to the built-in memory, set the source memory media to “Memory Card” (p. 29).

2 Select MENU → the tab → “File Copy,” and then press ►/ENTER.

The “Copy to Memory Card Select Folder” or the “Copy to Built-In Memory Select Folder” animation appears and the folder selection window is displayed.

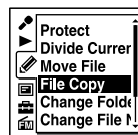

3 Press ◀◀, press ▲ or ▼ to select the tab or the tab, and then press ►/ENTER.

4 Press ▲ or ▼ to select the folder that you want to copy the file into, and then press ►/ENTER.

The “Copying...” animation appears and the file is copied as the last file in the destination folder. A file will be copied with the identical file name.

5 Press ■ STOP to exit the menu mode.

To cancel the copy operation

Press ■ STOP before step 4.

To cancel the copy operation during copying

While the “Copying...” animation is displayed in step 4, press ■ STOP.

Using a Track Mark

Adding a track mark

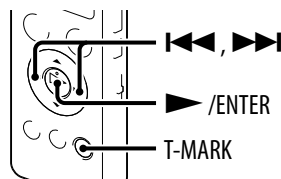



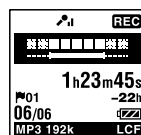

You can add a track mark at a point at which you would like to divide a file later or locate during playback. You can add a maximum of 98 track marks to each file.

During recording, playing back, or recording pausing, press T-MARK at the position you want to add a track mark. The  (Track mark) indicator flashes three times, and a track mark is added.



Locating a track mark and starting playback at the track mark

Press  or  in the stop mode. When the  (Track mark) indicator flashes once, press  /ENTER.

Erasing a track mark

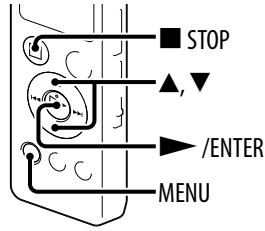

1 Stop at a position after the track mark you would like to erase.

2 Select MENU → the  tab → “Erase Track Mark,” and then press /ENTER.

“Erase Track Mark?” will be displayed.

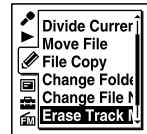

3 Press  or  to select “Execute,” and then press /ENTER.

The “Erasing...” animation appears in the display window and the selected track mark will be erased.

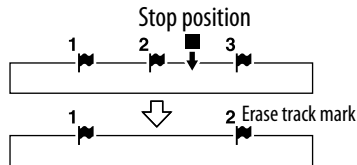

The track mark just before the stop position will be erased.

4 Press  STOP to exit the menu mode.

To cancel erasing

Select “Cancel” in step 3, and then press /ENTER.

Erasing all the track marks in the selected file at one time

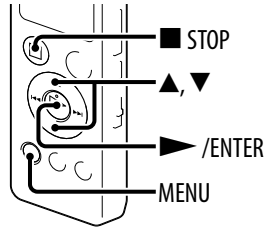

1 Select a file from which you want to erase the track marks.

2 Select MENU → the  tab → “Erase All Track Marks,” and then press ►/ENTER.

“Erase All Track Marks?” will be displayed.



3 Press ▲ or ▼ to select “Execute,” and then press ►/ENTER.

The “Erasing...” animation appears in the display window and all the track marks will be erased at one time.

4 Press ■ STOP to exit the menu mode.

To cancel erasing

Select “Cancel” in step **3**, and then press ►/ENTER.

Dividing a File

Dividing a file at the current position

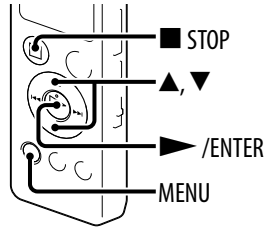

You can divide a file in the stop mode, so that the file is divided into two parts and new file numbers are added to the divided file names. By dividing a file, you can easily find the point from which you want to play back when you make a long recording such as at a meeting. You can divide a file until the total number of files in the folder reaches the maximum number allowed.

1 Stop the file at the position where you want to divide a file.

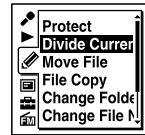

2 Select MENU → the  tab → “Divide Current Position,” and then press  /ENTER.

“Divide?” will be displayed.



3 Press  or  to select “Execute,” and then press  /ENTER.

The “Dividing...” animation appears, and the divided files will be suffixed with a sequential number (“_1” for the original file, and “_2” for the new file).

File 1	File 2	File 3
	 A file is divided. 	
File 1	File 2_1	File 2_2

A suffix made up of a sequential number is added to a file name of the divided files.



4 Press  STOP to exit the menu mode.

To cancel dividing

Select “Cancel” in step **3**, and then press  /ENTER.

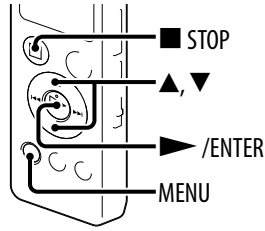
Dividing a file at all the track mark positions



- 1 Select the file you want to divide.
- 2 In the stop mode, select MENU → the  tab → “Divide All Track Marks,” and then press /ENTER. “Divide All Track Marks?” will be displayed.

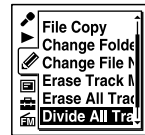

- 3 Press  or  to select “Execute,” and then press /ENTER.

The “Dividing...” animation appears, and the file is divided at all the track mark positions. All the existing track marks in the files will be erased. A suffix made up of a sequential number is added each of the divided files.

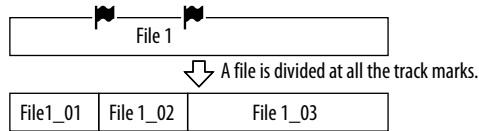

- 4 Press  STOP to exit the menu mode.

To cancel dividing

Select “Cancel” in step **3**, and then press /ENTER.

Renaming a Folder and a File

Changing a folder name

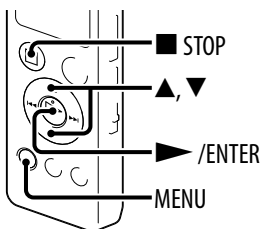

You can change a name of a folder used to store files recorded with the IC recorder.

You can choose a new folder name from the templates.

1 Select the folder which you want to rename from the  tab of the folder list.

2 In the stop mode, select MENU → the  tab → “Change Folder Name,” and then press /ENTER.

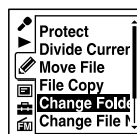

3 Press  or  to select a favorite folder name, and then press /ENTER.

You can choose a new folder name from the templates. “Executing...” appears in the display window and the folder name will be changed.

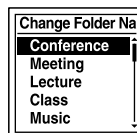



4 Press  STOP to exit the menu mode.

Hints

- When you specify a folder name that already exists, a suffix made up of a sequential number (2 to 10) is added to the name of the new folder.
- When you choose “FOLDER” from the templates, a suffix made up of a sequential number (01 to 10) is added to each of the folder names.
- You can use the supplied Sound Organizer software to rename a folder.

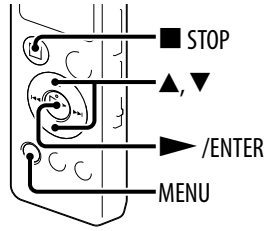
Changing a file name





You can rename a file by prefixing characters from a desired template to the file name. A file in the recordable area, or in a folder on the  tab, can be renamed. You can choose characters to be added from the templates.

- 1 Select the file which you want to rename from the  tab of the folder list.

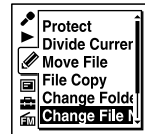
- 2 In the stop mode, select MENU  the  tab  "Change File Name," and then press  /ENTER.



- 3 Press  or  to select the desired characters to be prefixed to the file name, and then press  /ENTER.

You can choose characters from the templates. "Executing..." appears in the display window and the selected characters are added to the file name separated from it by an underbar (_). (e.g. If "A" is added to the file 11215_001: A_11215_001)

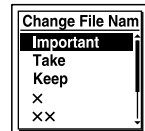

- 4 Press  STOP to exit the menu mode.

Hint

You can use the supplied Sound Organizer software to rename a file.

Protecting a File

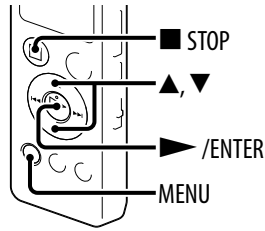

To prevent a file from being accidentally erased or edited, you can protect an important file. A protected file is marked with the Ⓜ (protect) indicator and is regarded as a read-only file you cannot erase or edit.

- 1 **Display the file which you want to protect from the ☰ tab or the 🎵 tab.**
- 2 **In the stop mode, select MENU \rightarrow the 🔍 tab \rightarrow "Protect," and then press \blacktriangleright /ENTER.**
"Set Protection?" will be displayed.
- 3 **Press \blacktriangle or \blacktriangledown to select "Execute," and then press \blacktriangleright /ENTER.**
The file is protected. A protected file is marked with the Ⓜ (protect) indicator.
- 4 **Press \blacksquare STOP to exit the menu mode.**

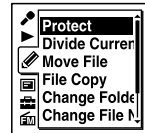

To release protection

Select the protected file, and then proceed with steps 2 through 4. In this case, "Erase Protection?" will be displayed in step 2.

Tuning in an FM Radio Station

Tuning in a radio station by scanning frequencies

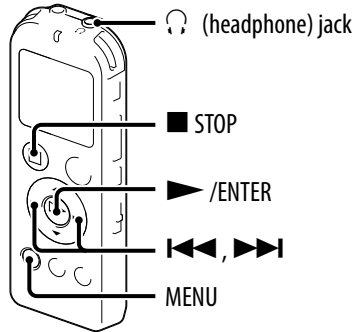

The headphone cord of the supplied stereo headphones works as an FM antenna, when you listen to the FM radio. Therefore, connect the stereo headphones to the (headphone) jack and stretch the cord as long as possible. When you listening the FM radio with the built-in speaker, connect the stereo headphones to the (headphone) jack and stretch the cord as long as possible.

- 1 In the sop mode, select MENU → the  tab → “FM Radio,” and then press ►/ENTER.**

The IC recorder enters the FM radio mode.

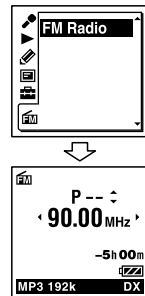

- 2 Select the audio output either from “Headphones” or “Speaker.”**
To select the audio output, select MENU → the  tab → “Audio Output” ( p. 77).

- 3 Press ◀◀ or ▶▶ repeatedly to tune in a station.**

- 4 Press ■ STOP to turn the FM radio off.**

To scan radio frequencies automatically

In step 3, press and hold ◀◀ or ▶▶ until the frequency digits begin to change on the display. The IC recorder automatically scans the radio frequencies and stops when it finds a clear station.

If you cannot tune in a station, press ◀◀ or ▶▶ repeatedly to change the frequency step by step.

Display when listening to the FM radio

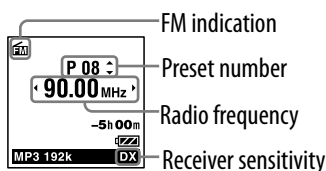

Tuning in a preset radio station

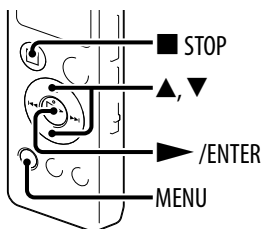

When you have already preset FM radio stations (☞ p. 72), you can tune in a station by selecting a preset number.

- 1 In the stop mode, select MENU → the  tab → "FM Radio," and then press ►/ENTER.**

The IC recorder enters the FM radio mode.

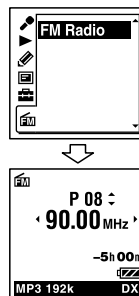

- 2 Select the audio output either from "Headphones" or "Speaker."**
To select the audio output, select MENU → the  tab → "Audio Output" (☞ p. 77).
- 3 Press ▲ or ▼ repeatedly until the preset (P) number you want is displayed.**
- 4 Press ■ STOP to turn the FM radio off.**

Recording FM broadcasts

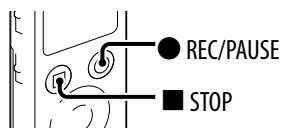

- 1 Tune in the station you want to record.**
- 2 Press ● REC/PAUSE to start recording.**
- 3 Press ■ STOP to stop recording.**

Presetting FM Radio Stations

Presetting FM radio stations automatically

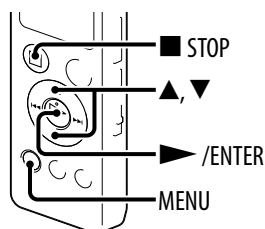

You can automatically tune in radio stations and then register them with preset numbers. You can preset up to 30 FM radio stations automatically using the preset menu.

- 1 In the FM radio reception mode, select MENU → the  tab → "Auto Preset," and then press ►/ENTER.**
"Auto Preset?" will be displayed.

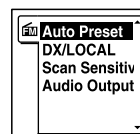

- 2 Press ▲ or ▼ to select "Execute," and then press ►/ENTER.**

The IC recorder automatically scans for available radio frequencies and the stations will be stored in memory from the lower frequencies to the higher ones.

While presetting FM radio stations automatically, the preset number ready to be assigned flashes.

To stop the automatic presetting

Press ■ STOP. The preset numbers stored until you press the ■ STOP button remain in memory.

Presetting FM radio stations manually

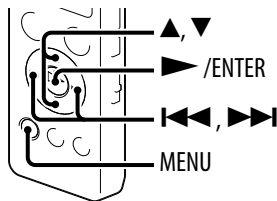

You can store an unregistered FM radio station on a preset number.

- 1 In the sop mode, select MENU → the  tab → "FM Radio," and then press ►/ENTER.**

The IC recorder enters the FM radio mode.

- 2 Press ◀◀ or ▶▶ repeatedly to tune in the station you want to preset and store on a preset number.**

When the station you want to tune in is not a preset station, "P - -" is displayed. In this case, you can register it with a new preset number.

- 3 Press ►/ENTER.**

The preset number, frequency and "Set?" will be displayed on the display.

- 4 Press ▲ or ▼ to select "Execute," and then press ►/ENTER.**

The station will be stored in memory on the preset number.

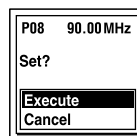

Erasing preset FM radio stations

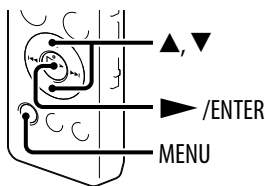

- 1 In the sop mode, select MENU → the  tab → "FM Radio," and then press ►/ENTER.**

The IC recorder enters the FM radio mode.

- 2 Press ▲ or ▼ repeatedly until the preset (P) number you want to erase is displayed.**

- 3 Press ►/ENTER.**

The preset number, frequency and "Erase?" will be displayed on the display.

- 4 Press ▲ or ▼ to select "Execute," and then press ►/ENTER.**

The preset number will be changed to "P - -."

Changing the FM Radio Reception Settings

Switching the receiver sensitivity of the FM radio

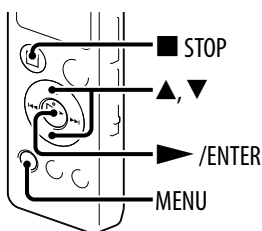

You can set the receiver sensitivity when listening to the FM radio.

- 1 In the FM radio reception mode, select MENU → the  tab → "DX/LOCAL," and then press ►/ENTER.**

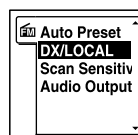

- 2 Press ▲ or ▼ to select "DX" or "LOCAL," and then press ►/ENTER.**
- 3 Press ■ STOP to exit the menu mode.**

DX	Normally, select this setting.
LOCAL	When there is interference or collapsing caused by a intense electric field around the transmitting antenna of the broadcasting station, etc., select this setting.

Switching the scanning sensitivity

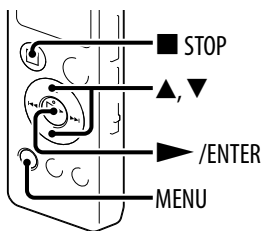

You can set the scanning sensitivity when presetting FM radio stations.

- 1 In the FM radio reception mode, select **MENU** → the **tab** → “Scan Sensitivity,” and then press **▶/ENTER**.

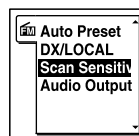

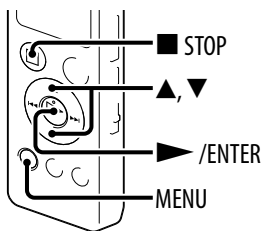

- 2 Press **▲** or **▼** to select “High(SCAN H)” or “Low(SCAN L),” and then press **▶/ENTER**.
- 3 Press **■ STOP** to exit the menu mode.

Switching the FM radio output between speaker and headphones





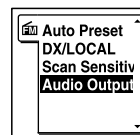

During receiving or recording an FM broadcast, you can switch between the sound from the speaker and the sound from the headphones using the menu.

- 1 In the FM radio reception or recording mode, select MENU → the  tab → “Audio Output,” and then press  /ENTER.**

In the FM reception mode, only the  tab is displayed. In the FM recording mode, the  tab and  tabs are displayed.



- 2 Press  or  to select “Headphones” or “Speaker,” and then press  /ENTER.**
- 3 Press  STOP to exit the menu mode.**

Making Settings for the Menu

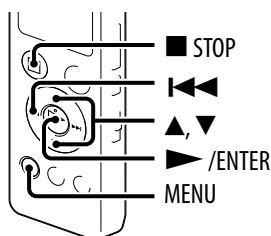

- 1 Press **MENU** to enter the menu mode.
The menu mode window will be displayed.

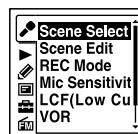

- 2 Press **Left Arrow**, press **Up** or **Down** to select the **Scene Select**, **Scene Edit**, **REC Mode**, **Mic Sensitivit**, **LCF(Low Cu**, or **VOR** tab, and then press **Right Arrow/ENTER**.
- 3 Press **Up** or **Down** to select the menu item for which you want to make setting, and then press **Right Arrow/ENTER**.
- 4 Press **Up** or **Down** to select the setting that you want to set, and then press **Right Arrow/ENTER**.
- 5 Press **STOP** to exit the menu mode.

Note

If you do not press any button for 60 seconds, the menu mode is automatically canceled and the window will return to the normal display.

To return to the previous window

Press **Left Arrow** during menu mode.

To exit the menu mode

Press **STOP** or **MENU**.



Menu Settings





Tabs	Menu items	Operation mode (○ : the setting can be made/ — : the setting cannot be made)				
		Stop mode	Playback mode	Recording mode	FM radio reception mode* ¹	FM radio recording mode* ¹
🎧 (Recording)	Scene Select	○	—	—	—	—
	Scene Edit	○	—	—	—	—
	REC Mode	○	—	—	—	—
	Mic Sensitivity	○	—	○	—	—
	LCF(Low Cut)	○	—	○	—	—
	VOR	○	—	○	—	—
	SYNC REC	○	—	—	—	—
	Select Input	○	—	—	—	—
▶ (Playback)	Noise Cut Level	○	○	—	—	—
	Effect	○	○	—	—	—
	Easy Search	○	○	—	—	—
	Play Mode	○	○	—	—	—
	Alarm	○	—	—	—	—
	AVLS * ²	○	○	—	○	○
✎ (Edit)	Protect	○	—	—	—	—
	Divide Current Position	○	—	—	—	—
	Move File	○	—	—	—	—
	File Copy	○	—	—	—	—
	Change Folder Name	○	—	—	—	—
	Change File Name	○	—	—	—	—
	Erase Track Mark	○	—	—	—	—
	Erase All Track Marks	○	—	—	—	—
	Divide All Track Marks	○	—	—	—	—
	Erase All	○	—	—	—	—









*¹ for ICD-UX522F/UX523F only / *² for the European models only

Tabs	Menu items	Operation mode (○ : the setting can be made/ — : the setting cannot be made)				
		Stop mode	Playback mode	Recording mode	FM radio reception mode* ¹	FM radio recording mode* ¹
☰ (Display)	Calendar	○	—	—	—	—
	Display	○	○	○	—	○
	LED	○	—	—	—	—
	Backlight	○	—	—	—	—
📁 (IC recorder setting)	Select Memory	○	—	—	—	—
	Language	○	—	—	—	—
	Date&Time	○	—	—	—	—
	Time Display	○	—	—	—	—
	Beep	○	—	—	—	—
	USB Charge	○	—	—	—	—
	Auto Power Off	○	—	—	—	—
	Format	○	—	—	—	—
📻 (FM radio)* ¹	FM Radio* ¹	○	—	—	—	—
	Auto Preset* ¹	—	—	—	○	—
	DX/LOCAL* ¹	—	—	—	○	○
	Scan Sensitivity* ¹	—	—	—	○	—
	Audio Output* ¹	—	—	—	○	○

*¹ for ICD-UX522F/UX523F only

Tabs	Menu items	Settings (* : Initial setting)
 (Recording)	Scene Select (🔧 p. 34)	Allows you to choose a recording scene according to each recording situation as follows: 🗣️ (Meeting), 🗣️ (Voice Notes), 🗣️ (Interview), 🗣️ (Lecture), 🗣️ (Audio IN), 🗣️ (My Scene). You can change the items for recording to the recommended settings in bulk.
	Scene Edit (🔧 p. 36)	Edits the settings of the various recording menu items which are pre-set in the “Scene Select” menu. Edit from Current Setting: Changes the settings that is pre-set in the menu. Set Default Value: Changes the settings to the default settings. Execute: Changes the settings to the default settings and completes the process. Cancel: Completes the process without changing the settings. Edit: Changes the settings from the settings in the selected scene item.  Hint You can edit the following menu items: “REC Mode” (🔧 p. 82), “Mic Sensitivity” (🔧 p. 82), “LCF(Low Cut)” (🔧 p. 83), “VOR” (🔧 p. 83) “SYNC REC” (🔧 p. 83), “Select Input” (🔧 p. 83). When you select “Edit Complete,” the process will be completed.

Tabs	Menu items	Settings (* : Initial setting)
 (Recording)	REC Mode	<p>Sets the recording mode.</p> <p>LPCM 44.1kHz/16bit: LPCM (not compressed) in stereo high-quality recording mode</p> <p>MP3 192kbps*: MP3 (compressed) in stereo standard-quality recording mode</p> <p>MP3 128kbps: MP3 (compressed) in long play stereo recording mode</p> <p>MP3 160kbps(MONO): MP3 (compressed) in monaural high-quality recording mode</p> <p>MP3 48kbps(MONO): MP3 (compressed) in monaural standard recording mode</p> <p>MP3 8kbps(MONO): MP3 (compressed) in long play monaural recording mode</p> <p>Note</p> <p>You cannot record an FM radio broadcast in the LPCM mode. When the LPCM mode is selected, the radio broadcast will be automatically recorded in the MP3 192kbps mode.</p>
	Mic Sensitivity	<p>Sets the microphone sensitivity.</p> <p>High  :</p> <p>To record a sound far away from the IC recorder or a low sound, such as recording in a spacious room.</p> <p>Medium  *:</p> <p>To record the sound of a normal conversation or meeting, such as recording in a meeting space or during interview.</p> <p>Low  :</p> <p>To record dictation with a microphone in front of your mouth, a sound near the IC recorder, or a loud sound.</p> <p>Note</p> <p>During recording an FM radio broadcast ( p. 71), the Mic Sensitivity setting is disabled.</p>

Tabs	Menu items	Settings (* : Initial setting)
 (Recording)	LCF(Low Cut)	<p>Sets the LCF (Low Cut Filter) function to cut a low frequency to reduce the roaring noise from wind; therefore you can record a file more clearly.</p> <p>ON: The LCF function is activated.</p> <p>OFF*: The LCF function is canceled.</p> <p>Note</p> <p>During recording an FM radio broadcast ( p. 71), the LCF function does not work.</p>
	VOR ( p. 38)	<p>Sets the VOR (Voice Operated Recording) function.</p> <p>ON: Recording starts when the IC recorder detects sound and pauses when no sound is heard, eliminating recording during soundless periods. The VOR function is activated when  REC/PAUSE is pressed.</p> <p>OFF*: The VOR function does not work.</p> <p>Note</p> <p>During recording an FM radio broadcast ( p. 71), the VOR function does not work.</p>
	SYNC REC ( p. 40)	<p>When set to “ON,” the IC recorder enters the recording pause mode when no sound is detected for more than 2 seconds, and the IC recorder starts recording again as a new file when any sound is detected.</p> <p>ON: The synchronized recording function is activated.</p> <p>OFF*: The synchronized recording function is canceled.</p>
	Select Input ( p. 39, 40)	<p>Selects the external input to be recorded that is connected to the  (microphone) jack.</p> <p>MIC IN*: Select when you record files using an external microphone.</p> <p>Audio IN: Select when you record using other equipment.</p>

Tabs	Menu items	Settings (* : Initial setting)
▶ (Playback)	Noise Cut Level (☞ p. 45)	<p>Adjusts the level of the noise cut function.</p> <p>Maximum*: The noise cut levels will be more intense.</p> <p>Medium: The noise cut level will be weakened. Select when you cannot catch the sound easily by setting “Noise Cut Level” to “Maximum.”</p> <p>Note</p> <p>When playing back files using the built-in speaker or recording an FM radio broadcast (☞ p. 71), the noise cut function does not work.</p>
	Effect (☞ p. 47)	<p>Sets the effect you want for the playback.</p> <p>Pop: Stresses middle ranges, ideal for vocals.</p> <p>Rock: Emphasizes high and low ranges for a powerful sound.</p> <p>Jazz: Emphasizes high ranges for lively sound.</p> <p>Bass1: The bass sound is emphasized.</p> <p>Bass2: The bass sound is emphasized even more.</p> <p>Custom: You can design your own custom sound level for 5 bands of EQ (100 Hz, 300 Hz, 1 kHz, 3 kHz and 10 kHz) in 7 steps (-3 to +3).</p> <p>OFF*: The effect function does not work.</p> <p>Note</p> <p>When playing back files using the built-in speaker or listening to the FM radio (☞ p. 69), or when the NOISE CUT switch is set to “ON” (☞ p. 45), the effect function does not work.</p>



Tabs	Menu items	Settings (* : Initial setting)
▶ (Playback)	Easy Search (☞ p. 51)	<p>Sets the easy search function.</p> <p>ON: You can go forward or backwards for the specified skip time by pressing ►► or ◀◀ during playback. This function is useful when attempting to locate desired point in a long recording.</p> <p>OFF*: The easy search function does not work. When you press ►► or ◀◀, a file will be moved forward or backward.</p> <p>Set Skip Time: Sets the time to go forward or backward in easy searching.</p> <p>Setting Complete: Changes the settings and completes the process.</p> <p>Forward Skip Time: Sets the time to skip forward when you press ►►. (5sec, 10sec*, 30sec, 1min, 5min, or 10min)</p> <p>Reverse Skip Time: Sets the time to skip backwards when you press ◀◀. (1sec, 3sec*, 5sec, 10sec, 30sec, 1min, 5min, or 10min)</p>
	Play Mode (☞ p. 49)	<p>Sets the playback mode.</p> <p>1: A file is played back.</p> <p>☐*: Files in one folder are played back continuously.</p> <p>ALL: All the files are played back continuously.</p> <p>↺ 1: One file is played back repeatedly.</p> <p>↺ ☐: Files in one folder are played back repeatedly.</p> <p>↺ ALL: All the files are played back repeatedly.</p>

Tabs	Menu items	Settings (* : Initial setting)
▶ (Playback)	Alarm (🔔 p. 54)	<p>Sets the alarm.</p> <p>ON: The alarm function is effective. Set the date, time or day of the week or choose daily for playback, and set the following alarm pattern.</p> <p>Beep&Play: The selected file is played back after the alarm sounds.</p> <p>Beep: Only the alarm sounds.</p> <p>Play: Only the selected file is played back.</p> <p>OFF*: The alarm function is canceled.</p>
	AVLS * ² (🔊 p. 17)	<p>Sets the AVLS (Automatic Volume Limiter System) function.</p> <p>ON*: The AVLS function that maintains a moderate volume level is effective when listening with the headphones.</p> <p>OFF: The AVLS function does not work and the sound is played back at the original volume.</p> <p>Notes</p> <ul style="list-style-type: none"> • When you turn off the function, please be careful not to listen to an excessive volume of the sound. • When you listen to the sound using the headphones for the specific period of time, the AVLS function is automatically turned on even if you set “AVLS” to “OFF” in the menu. • If you adjust the volume to a level that exceeds the AVLS-specified level, the volume will be set to a moderate volume level when you turn off the IC recorder.

*² for the European models only

Tabs	Menu items	Settings (* : Initial setting)
✎ (Edit)	Protect (☞ p. 68)	Protects the selected file to prevent the file from being erased, divided, or being moved. Execute: The selected file will be protected. If you specify a file that has already been protected, cancel the protection. Cancel: Protection or cancel protection is not executed.
	Divide Current Position (☞ p. 64)	Divides a file into two. Execute: A file will be divided into two. Cancel: Division is not executed.
	Move File (☞ p. 59)	Moves the selected file to the selected folder. Before attempting to move a file, select the file to be moved, and then go to the menu window.
	File Copy (☞ p. 60)	Copies the selected file from the built-in memory to the desired folder on a memory card, or from a memory card to the desired folder on the built-in memory. Before attempting to copy a file, select the file to be copied and then go to the menu window.
	Change Folder Name (☞ p. 66)	Renames a folder by selecting a template.
	Change File Name (☞ p. 67)	Renames a file by selecting a template and prefixing the characters of the selected template to the file name.
	Erase Track Mark (☞ p. 62)	Erases the track mark just before the current position. Execute: The track mark will be erased. Cancel: The track mark will not be erased.
	Erase All Track Marks (☞ p. 63)	Erases all the track marks of the selected file. Execute: All the track marks will be erased. Cancel: All the track marks will not be erased.

Tabs	Menu items	Settings (* : Initial setting)
✎ (Edit)	Divide All Track Marks (☞ p. 65)	Divides a file at all the track mark positions. Execute: The track mark division is executed. Cancel: The track mark division is not executed.
	Erase All (☞ p. 58)	Erases all files in the selected folder. Press FOLDER to return to the folder window before erasing the files and select a folder from which all files are to be erased, and then go to the menu window. Execute: All files in the selected folder will be erased. Cancel: All files will not be erased.
☑ (Display)	Calendar (☞ p. 52)	Switches the display window to a calendar, and plays back a file recorded with the IC recorder by selecting a date from the calendar. Enter: The selected file is played back. Back: The IC recorder does not play the selected file and returns to the previous window.
	Display	Changes the display mode. Elapsed Time*: Elapsed playback time of one file Remain Time: During stop or playback, the remaining time of one file During recording, the available recording time REC Date: Date recorded REC Time: Time recorded

Tabs	Menu items	Settings (* : Initial setting)
 (Display)	LED	<p>Turns the operation indicator on or off during operation.</p> <p>ON*: During recording or playback, the operation indicator lights or flashes.</p> <p>OFF: The operation indicator does not light or flash, even during operation.</p> <p>Note</p> <p>When the IC recorder is connected to a computer, the operation indicator lights or flashes even if “LED” is set to “OFF”</p>
	Backlight	<p>Turns the backlight in the display window on or off.</p> <p>ON*: The backlight in the display window lights up for approx. 10 seconds.</p> <p>OFF: The backlight in the display window does not light, even during operation.</p>
 (IC recorder setting)	Select Memory (☞ p. 29)	<p>Selects the memory media on which you want to store a file, or which contains the file you want to play, edit, or copy.</p> <p>Built-In Memory*: The built-in memory of the IC recorder is selected.</p> <p>Memory Card: The memory card inserted in the memory card slot is selected.</p> <p>Note</p> <p>When no memory card is currently inserted in the IC recorder, the built-in memory is automatically selected.</p>

Tabs	Menu items	Settings (* : Initial setting)
 (IC recorder setting)	Language (☞ p. 26)	Sets the language to be used for messages, menus, folder names, file names, etc. Deutsch (German), English, Español (Spanish), Français (French), Italiano (Italian), Русский (Russian), 日本語 (Japanese), 한국어 (Korean), 繁體中文 (Chinese), 简体中文 (Chinese), ไทย (Thai) Note Number of language options you can select and the default setting differ depending on the country or region you purchased your IC recorder.
	Date&Time (☞ p. 24)	Auto(Synchronizing)*: When the IC recorder is connected to a computer that is running the Sound Organizer, the clock will be automatically adjusted according to that computer. Manual: Sets the clock by setting year, month, day, hour, and minute in sequence.
	Time Display	Sets the clock display. 12-Hour: 12:00AM = midnight, 12:00PM = noon 24-Hour: 0:00 = midnight, 12:00 = noon Note The default setting differs depending on the area you purchased your IC recorder.
	Beep	Sets whether a beep will be heard or not. ON*: A beep will sound to indicate that an operation has been accepted or an error has occurred. OFF: No beep sound will be heard. Note The alarm sounds even if you set “Beep” to “OFF” in the menu.

Tabs	Menu items	Settings (* : Initial setting)
 (IC recorder setting)	USB Charge	Sets whether battery will be charged using a USB connection or not. ON*: The battery will be charged. OFF: The battery will not be charged. Note If you use a USB AC adaptor (not supplied) to connect the IC recorder to the AC outlet (☞ p. 111), you can charge battery regardless this setting.
	Auto Power Off	If the IC recorder is on and left for the period you have set, the IC recorder turns off automatically. 5min: The IC recorder will be turned off after approx. 5 minutes. 10min*: The IC recorder will be turned off after approx. 10 minutes. 30min: The IC recorder will be turned off after approx. 30 minutes. 60min: The IC recorder will be turned off after approx. 60 minutes. OFF: The IC recorder will not be turned off automatically.

Tabs	Menu items	Settings (* : Initial setting)
 (IC recorder setting)	Format	<p>Formats the memory media currently selected (the built-in memory or the memory card), erasing all the data in the memory and resetting the folder structure to its default status.</p> <p>Execute: The “Formatting...” animation appears and the memory media will be formatted.</p> <p>Cancel: The memory media will not be formatted.</p> <p>Notes</p> <ul style="list-style-type: none"> • Use the IC recorder formatting function to format the memory media. Do not use your computer to format the media. • Switch the memory media to the one to be formatted before you start the format operation (☞ p. 29). • When you format the memory media, all the data which you have stored on the media will be erased. Once the memory media has been erased, you cannot retrieve the data that was erased. • When you format the built-in memory, the operating instructions stored in the built-in memory will also be erased. To get another copy of the operating instructions, please visit the Sony support home page depending on your area (☞ p. 121).
	System Information	Displays the IC recorder model name and the version number of the software.

Tabs	Menu items	Settings (* : Initial setting)
 (FM radio)* ¹	FM Radio* ¹ (☞ p. 69)	<p>The IC recorder enters the FM radio mode.</p> <p>Notes</p> <ul style="list-style-type: none"> • While the FM radio is activated, you cannot change memory media or select a folder. Before starting FM radio recording, select the memory media and folder you want to use to record the FM broadcast in advance. • You cannot record an FM broadcast in LPCM mode. When “REC Mode” is set to “LPCM 44.1kHz/16bit,” an FM broadcast is recorded in “MP3 192kbps.” • During recording an FM radio broadcast, the Mic Sensitivity, VOR, LCF (Low Cut Filter), and noise cut functions are disabled.
	Auto Preset* ¹ (☞ p. 72)	<p>Scans automatically for available frequencies. The stations will be stored in memory.</p> <p>Execute: The automatic presetting is executed.</p> <p>Cancel: The automatic presetting is canceled.</p>
	DX/LOCAL* ¹ (☞ p. 75)	<p>Sets the receiver sensitivity when listening to the FM radio.</p> <p>DX*: Normally, select this setting.</p> <p>LOCAL: When there is interference or collapsing caused by a intense electric field around the transmitting antenna of the broadcasting station, etc., select this setting.</p> <p>Note</p> <p>Select “DX” when the IC recorder reception status is not good due to a weak signal.</p>

*¹ for ICD-UX522F/UX523F only

Tabs	Menu items	Settings (* : Initial setting)
 (FM radio)* ¹	Scan Sensitivity* ¹ (🔍 p. 76)	Sets the scanning sensitivity when presetting FM radio stations. High(SCAN H)*: The scanning sensitivity is set to high. Low(SCAN L): The scanning sensitivity is set to low.
	Audio Output* ¹ (🔊 p. 77)	During FM reception or recording, switches between the sound from the speaker and the sound from the headphones. Headphones*: The sound comes out from the headphones. Speaker: The sound comes out from the speaker(s).

*¹ for ICD-UX522F/UX523F only

Using the IC Recorder with Your Computer

When the IC recorder is connected to your computer, you can transfer data between them.

Copying files from the IC recorder to your computer to store them (👉 p. 101)

Copying music files from your computer to the IC recorder to play them back (👉 p. 102)

Using the IC recorder as USB memory (👉 p. 104)

You can store image data or text data stored on the computer temporarily in the IC recorder.

Managing and editing files using the Sound Organizer software (👉 p. 105)

The supplied Sound Organizer software allows you to transfer the files that you have recorded using the IC recorder to your computer to manage and edit them. You can also transfer music files and podcast files stored on your computer to the IC recorder.

System requirements for your computer

For details on the system requirements for your computer, see page 107, 115.

Connecting the IC recorder to your computer

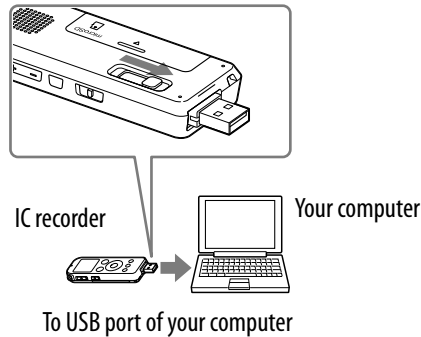

To exchange files between the IC recorder and your computer, connect the IC recorder to your computer.

- 1 Slide the USB DIRECT slide lever on the back of the IC recorder, and insert the USB connector into the USB port of a running computer.**
- 2 Make sure the IC recorder has been recognized properly.**
 On the Windows screen; open “My Computer” or “Computer,” and make sure that “IC RECORDER” or “MEMORY CARD” has been recognized.
 On the Macintosh screen; make sure that an “IC RECORDER” or “MEMORY CARD” drive is displayed on the Finder.

The IC recorder is recognized by the computer as soon as the connection is made. While the IC recorder is connected to the computer, “Connecting” is displayed in the display window of the IC recorder.

If the IC recorder cannot be connected to a computer directly, use the supplied USB connection support cable.

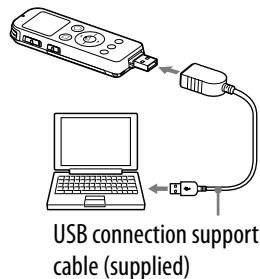

Structure of folders and files

The folders and files are displayed on the computer screen as shown. On a Windows screen using Explorer, and on a Macintosh screen using Finder, folders and files can be displayed by opening “IC RECORDER” or “MEMORY CARD.”

When connecting the IC recorder with your computer after the destination memory media has been set to “Memory Card” (☞ p. 29), the structure of folders is different from that when the destination memory media is set to “Built-In Memory.”

Built-in memory

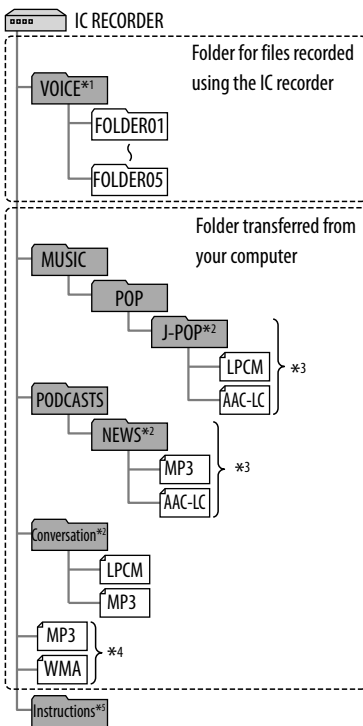

microSD card

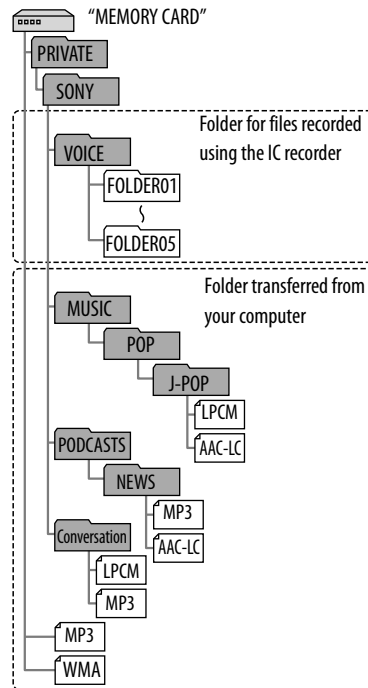

*1 Even if a file is transferred directly under the VOICE folder, it will not be displayed on the ☺ tab of the IC recorder. When you transfer a file from your computer to the IC recorder, put the file in the folders under the VOICE folder.

*2 The name of a folder in which music files are stored will be displayed on the IC recorder as it is, so it is convenient if you put an easy-to-remember name on the folder in advance.

Folders shown in the illustration are examples of folder names.

*3 The IC recorder can recognize up to 8 levels of folders transferred to the IC recorder.

*4 If you transfer music files separately, they are classified as being in “No Folder.”

*5 The operating instructions of the IC recorder are stored in the “Instructions” folder directly under the “IC RECORDER” folder.



Hints

- The title or artist name, etc., registered in the music files, can be displayed on the IC recorder. It is useful if you input the ID3 tag information using the software you use to make the music files on your computer.
- If no title, or artist name has been registered “No Data” will be displayed in the display window of the IC recorder.

Structure of folders displayed in the display window of the IC recorder

The display of the structure of the folders seen in the display window of the IC recorder is different from that seen on the display of a computer.

The folder indicators in the display window of the IC recorder are as follows:

-  : Folder for files recorded using the IC recorder
-  : Folder transferred from a computer (They are displayed when music files have been transferred from a computer.)
-  : Folder for podcast files transferred from a computer (These folders are displayed when podcast files have been transferred from a computer.)

Note

If folders have no files that can be played back using the IC recorder, those folders will not be displayed in the display window of the IC recorder.

Folders displayed on the tab of the IC recorder



Folders for files recorded using the IC recorder (folders under the VOICE folder) will be displayed.

Note

Even if a file is transferred directly under the VOICE folder, it will not be displayed on the  tab of the IC recorder.

Folders displayed on the tab of the IC recorder



The following folders will be displayed among the folders forwarded from a computer.

- Folders under the MUSIC folder which contains a file (when some folders have multiple levels, all folders will be displayed in parallel.)
- Folders transferred to places other than under the MUSIC folder or the PODCASTS folder
- A folder called “No Folder” (If you transfer music files separately, those files will be displayed under this folder.)

Folders displayed on the tab of the IC recorder



Folders for podcast files transferred from a computer will be displayed. When you transfer podcast files from your computer to the IC recorder, use the supplied Sound Organizer software.

Disconnecting the IC recorder from your computer

Follow the procedures below; otherwise, data may be damaged.

1 Make sure that the operation indicator of the IC recorder does not light.

2 Perform the following operation on your computer.

On the Windows taskbar at the bottom right of the desktop, left-click the following icon:



➔ Left-click “Eject IC RECORDER” (Windows 7), or “Safely remove USB Mass Storage Device” (Windows XP, Windows Vista).

The icon and menu displayed can be different on different operating systems. The icon may not be always displayed on the taskbar depending on your computer settings.

On a Macintosh screen, drag “IC RECORDER” on the Finder to “Trash” and drop it there.

For details on disconnecting the IC recorder from your computer, refer to the operating instructions supplied with your computer.

3 Disconnect the IC recorder from the USB port of the computer, and slide the USB DIRECT slide lever in the direction of the arrow to retract the USB connector.

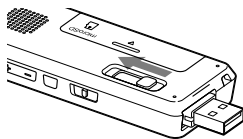

Copying Files from the IC Recorder to Your Computer

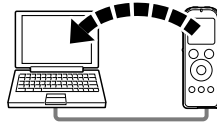

You can copy the files and folders from the IC recorder to your computer to store them.

1 Connect the IC recorder to your computer (🔗 p. 96).

2 Copy files or folders you want to transfer to your computer.

Drag and drop the files or folders you want to copy from “IC RECORDER” or “MEMORY CARD” to the local disk on your computer.

💡 To copy a file or folder (Drag and drop)

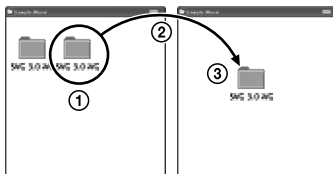

IC RECORDER or
MEMORY CARD

Your computer

- ① Click and hold,
- ② drag,
- ③ and then drop.

3 Disconnect the IC recorder from your computer (🔗 p. 100).

Copying Music Files from Your Computer to the IC Recorder and Playing Them Back

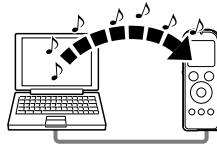

You can copy music or the other audio files (LPCM(.wav)/MP3(.mp3)/WMA(.wma)/AAC-LC(.m4a)*) from your computer to the IC recorder by dragging and dropping them, and you can play them back using the IC recorder.

* For the file formats that can be played back using the IC recorder, see “Specifications” (📖 p. 115).

Copying a music file from your computer to the IC recorder (drag and drop)

1 Connect the IC recorder to your computer (📖 p. 96).

2 Copy the folder in which the music files are stored to the IC recorder.

On a Windows screen using Explorer, or on a Macintosh screen using Finder, drag and drop the folder containing the music files onto “IC RECORDER” or “MEMORY CARD.”

The IC recorder can recognize up to 400 folders. You can copy up to 199 files to one folder. Moreover, the IC recorder can recognize up to a total of 4,095 folders and files for one memory media.

3 Disconnect the IC recorder from your computer (📖 p. 100).

Playing back music files copied from your computer using the IC recorder

- 1 Press **FOLDER**.
- 2 Press **⏪**, press **▲** or **▼** to select the **🎵** tab, and then press **▶** / **ENTER**.
- 3 Press **▲** or **▼** to select the folder (📁) in which music files are stored, and then press **▶** / **ENTER**.
To display the files contained in the selected folder, press **▶▶**.
- 4 **Select the music file you want to play.**
When the file selection window is displayed, press **▲** or **▼** to select the desired file, and then press **▶** / **ENTER**.
When the stop mode window is displayed, you can switch files by pressing **⏪** and **▶▶**.
- 5 Press **▶** / **ENTER** to start playback.
- 6 Press **■ STOP** to stop playback.

Display when playing back a music file

Press **▲** or **▼** to check the music file information during playback.

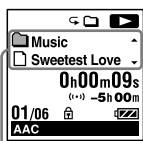

- 📁 : Folder name
- 📄 : File name
- 👤 : Artist name
- 🎵 : Title name

Using the IC Recorder as USB Memory

When the IC recorder is connected to your computer, image data or text data on the computer, as well as files recorded using the IC recorder can be temporarily stored on the IC recorder.

Your computer must meet the specified system requirements to use the IC recorder as USB memory.

For details on the system requirements, see page 115.

Using the Supplied Sound Organizer Software

What you can do using Sound Organizer

Sound Organizer allows you to exchange files with an IC recorder or memory card. The songs imported from music CDs and other media, MP3 and other audio files imported from a computer, and podcasts can also be played and transferred to an IC recorder. Various operations can be performed for imported files, including playback, editing and conversion to MP3 and other formats. You can also burn CDs of the music you like, and send audio files by mail.

Importing files recorded with an IC recorder

You can import recording files that were recorded with an IC recorder into Sound Organizer.

The imported files are saved to the computer.

Importing songs from a music CD

You can import the songs of a music CD into Sound Organizer.

The imported songs are saved to the computer.

Importing songs on the computer

You can import music and other files saved to the computer into Sound Organizer.

Subscribing to and updating podcasts

You can subscribe to podcasts in Sound Organizer.

Subscribing to and updating podcasts enables you to download (subscription) and enjoy the latest data from the Internet.

Playing files

You can play the files imported into Sound Organizer.

Changing the file information of files

You can change the title name, artist name, and other file information displayed in the file list.

Dividing files

You can divide one file into multiple files.

Combining files

You can combine multiple files into one file.

Editing templates for a folder or file name

You can edit the templates used as “Change File Name” and “Change Folder Name” menu options.

Deleting files from an IC recorder

You can delete a file saved to an IC recorder.

Use this operation to delete files in the IC recorder when you want to increase the amount of free space in the IC recorder or there are unnecessary files.

Transferring files to an IC recorder

You can transfer a file from Sound Organizer to an IC recorder or memory card.

You can enjoy transferred music, podcasts, and other content on your IC recorder.

Burning a music CD

You can select your favorite songs from the songs imported into Sound Organizer and then burn your own original music CD.

Other convenient uses

- You can start the mail software and send a recording file attached to mail.
- You can use the voice recognition software Dragon NaturallySpeaking (not supplied) which is compatible with Sound Organizer to perform voice recognition for a file and convert the voice to text.

System requirements for your computer

The following shows the system requirements for using Sound Organizer.

Operating systems

- Windows 7 Ultimate
- Windows 7 Professional
- Windows 7 Home Premium
- Windows 7 Home Basic
- Windows 7 Starter (32 bit version)
- Windows Vista Ultimate Service Pack 2 or higher
- Windows Vista Business Service Pack 2 or higher
- Windows Vista Home Premium Service Pack 2 or higher
- Windows Vista Home Basic Service Pack 2 or higher
- Windows XP Media Center Edition 2005 Service Pack 3 or higher
- Windows XP Media Center Edition 2004 Service Pack 3 or higher*
- Windows XP Media Center Edition Service Pack 3 or higher*
- Windows XP Professional Service Pack 3 or higher
- Windows XP Home Edition Service Pack 3 or higher

Pre-installed.

*Excluding China

Notes

- One of the above operating systems should be by default pre-installed. Upgraded operating systems or multi-boot environment are not supported.
- 64 bit versions of Windows XP are not supported.

IBM PC/AT or compatible

- CPU
 - Windows XP: Pentium III processor of 500 MHz or faster
 - Windows Vista: Pentium III processor of 800 MHz or faster
 - Windows 7: Pentium III processor of 1 GHz or faster
- Memory
 - Windows XP: At least 256 MB
 - Windows Vista: At least 512 MB (In the case of Windows Vista Ultimate/Business/Home Premium, at least 1 GB is recommended.)
 - Windows 7: At least 1 GB (32 bit version)/At least 2 GB (64 bit version)
- Free hard disk space
 - At least 400 MB is required.
 - Depending on the version of Windows, more than 400 MB may be used.
 - Also, free space for handling music data is required.
- Display settings
 - Screen resolution: 800 × 600 pixels or higher (1,024 × 768 pixels is recommended.)
 - Screen color: High Color (16 bit) or higher

- Sound card
A SoundBlaster compatible card is recommended.
- USB port
A compatible USB port is required to use devices and media.
Operation via a USB hub is not guaranteed except for models for which operation has been specifically guaranteed.
- Disk drive
A CD-ROM drive is required. To create a music CD, you need a CD-R/RW drive.

Installing Sound Organizer

Install Sound Organizer on your computer.

Notes

- When installing Sound Organizer, log in to an account with administrator privileges. Also, if you are using Windows 7 and the [User Account Control] screen appears, confirm the contents of the screen and then click [Yes] ([Continue] in the case of Windows Vista).
- Sound Organizer cannot be started by a user with limited privileges in Windows XP.
- To use the software update function in Windows XP, you must log on to an account with computer administrator privileges.
- The Windows Media Format Runtime module is added by the installer of Sound Organizer. This module is not removed when Sound Organizer is uninstalled. However, it may not be installed if it has been preinstalled.
- The data in the content storage folders is not deleted when Sound Organizer is uninstalled.
- In an installation environment in which multiple operating systems are installed on one computer, do not install Sound Organizer in each of the operating systems. Doing so may result in data inconsistencies.

1 Make sure that the IC recorder is not connected, then turn on your computer and start up Windows.

2 Insert the supplied CD-ROM into the CD-ROM drive.

The [Sound Organizer - InstallShield Wizard] menu starts up automatically and the [Welcome to Sound Organizer Installer] window appears.

If the [Welcome to Sound Organizer Installer] menu does not start up, open Windows Explorer, right-click the CD-ROM drive, double-click [SoundOrganizerInstaller.exe], and then follow the instructions on the screen.

-
- 3 Make sure that you accept the terms of the license agreement, select [I accept the terms in the license agreement], then click [Next].**

 - 4 When the [Setup Type] window appears, select [Standard] or [Custom], and then click [Next].**
Follow the instructions on the screen and set the installation settings when you select [Custom].

 - 5 When the [Ready to Install the Program] window appears, click [Install].**
The installation starts.

 - 6 When [Sound Organizer has been installed successfully.] window appears, check [Launch Sound Organizer Now], and then click [Finish].**
-

Note

You may need to restart your computer after installing Sound Organizer.

The Sound Organizer window

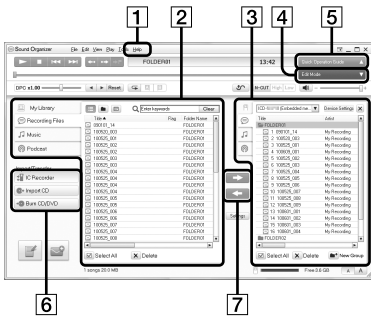

1 Help

Displays the help of Sound Organizer. For details on each operation, refer to these help files.

2 The file list of Sound Organizer (My Library)

Displays a list of files included in My Library of Sound Organizer in accordance with the operation.

☞ Recording Files : Displays a list of recording files.

Recording files that were recorded with an IC recorder appear in this library when they are imported.

🎵 Music: Displays a list of music files.

Songs imported from a music CD appear in this library.

🎧 Podcast: Displays a list of podcasts.

3 The file list of the IC recorder

Displays the files saved to the connected IC recorder or memory card.

4 Edit Mode button

Displays the edit area so that you can edit a file.

5 Quick Operation Guide button

Displays the Quick Operation Guide to receive guidance on the basic features of Sound Organizer.

6 Sidebar (Import/Transfer)

IC Recorder: Displays the transfer screen. A list of files on a connected device appears.

📀 Import CD: Displays the screen for importing music CDs.

🔥 Burn CD/DVD: Displays the screen for burning discs.

7 Transfer buttons

➡: Transfers the files of Sound Organizer to an IC recorder or memory card.

⬅: Imports the files of an IC recorder or memory card to My Library of Sound Organizer.

Using a USB AC Adaptor

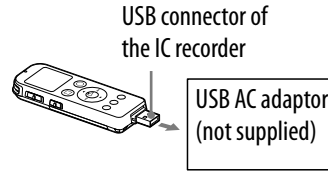

You can charge the rechargeable battery by connecting the IC recorder to an AC outlet using a USB AC adaptor (not supplied). You can charge the battery while you are using the IC recorder, so that it is useful when you want to record for a long time.

When you use the IC recorder for the first time, or after you have not used the IC recorder for a certain period of time, charge the battery continuously until “” is displayed.

It takes about 3 hours 30 minutes to fully charge an exhausted battery.*

* This is an approximation for the time it takes to charge from no remaining battery power to full battery power at room temperature. It varies depending on the remaining power and the condition of the battery.

1 Connect a USB AC adaptor (not supplied) to an AC outlet.

2 Slide the USB DIRECT slide lever on the back of the IC recorder and connect the USB connector to the USB AC adaptor.

While the battery is charging, the battery indicator is displayed in an animation.

Now you can use the IC recorder while charging the battery.

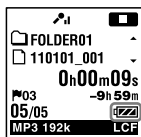

Notes

- While playing back files using the built-in speaker, you cannot charge the battery.
- You cannot charge an LR03 (size AAA) alkaline battery (not supplied).
- During the FM listening and recording, you cannot charge a battery.

Disconnecting the IC recorder from the AC outlet

Follow the procedures below; otherwise, when the IC recorder contains data files, the files may be damaged or become unplayable.

- 1 If you are recording or playing back a file, press ■ STOP to put the IC recorder into the stop mode.**
- 2 Make sure that the operation indicator of the IC recorder does not light.**
- 3 Disconnect the IC recorder from the USB AC adaptor, and then disconnect the USB AC adaptor from the AC outlet.**

Precautions

On power

Operate the unit only on 1.2 V or 1.5 V DC. Use one NH-AAA rechargeable battery or one LR03 (size AAA) alkaline battery.

On safety

Do not operate the unit while driving, cycling or operating any motorized vehicle.

On handling

- Do not leave the unit in a location near heat sources, or in a place subject to direct sunlight, excessive dust or mechanical shock.
- Should any solid object or liquid fall into the unit, remove the battery and have the unit checked by qualified personnel before operating it any further.
- Be careful not to allow water to splash on the unit. The unit is not water-proof. In particular, be careful in the following situations.
 - When you have the unit in your pocket and go to the bathroom, etc. When you bend down, the unit may drop into the water and may get wet.
 - When you use the unit in an environment where the unit is exposed to rain, snow, or humidity.
 - In circumstances where you get sweaty. If you touch the unit with wet hands or if you put the unit in the pocket of sweaty clothes, the unit may get wet.
- You may feel pain in your ears if you use the headphones when the ambient air is very dry. This is not because of a malfunction of the headphones, but because of static electricity accumulated in your body. You can reduce static electricity by wearing non-synthetic clothes that prevent the emergence of static electricity.

On noise

- Noise may be heard when the unit is placed near an AC power source, a fluorescent lamp or a mobile phone during recording or playback.
- Noise may be recorded when an object, such as your finger, etc., rubs or scratches the unit during recording.

On maintenance

To clean the exterior, use a soft cloth slightly moistened in water. Then use a soft dry cloth to wipe the exterior. Do not use alcohol, benzine or thinner.

If you have any questions or problems concerning your unit, please consult your nearest Sony dealer.

Backup recommendations

To avoid potential risk of data loss caused by accidental operation or malfunction of the IC recorder, we recommend that you save a backup copy of your recorded files to a computer, etc.

On using a memory card

- When formatting (initializing) a memory card, make sure to use the IC recorder to format it. Operations of the memory cards formatted with Windows or other devices are not guaranteed.
- If you format a memory card containing recorded data, the recorded data will be deleted. Be careful not to delete important data.
- Do not leave a memory card within the reach of small children. They might accidentally swallow it.
- Do not insert or remove a memory card during recording/playback/formatting. Doing so may cause a malfunction of the IC recorder.
- Do not remove a memory card while the “Accessing...” animation appears in the display window or the operation indicator is flashing in orange. Doing so may damage the data.
- We do not guarantee the operations of all types of compatible memory cards with the IC recorder.
- You cannot use a ROM (read-only-memory) type or write-protected memory card.
- Data may be corrupted in the following cases:
 - When a memory card is removed or the IC recorder is turned off during a read or write operation.
 - When a memory card is used in locations subject to static electricity or electrical noise.
- We assume no responsibility for any loss or damage of recorded data.
- We recommend that you save a backup copy of the important data.
- Do not touch the terminal of a memory card with your hand or a metal object.
- Do not strike, bend or drop a memory card.
- Do not disassemble or modify a memory card.
- Do not expose a memory card to water.
- Do not use a memory card under the following conditions:
 - Locations beyond the required operating conditions, including locations, such as the hot interior of a car parked in the sun and/or in the summer, the outdoors exposed to direct sunlight, or a place near a heater.
 - Humid locations or locations with corrosive substances present.
- When using a memory card, make sure to check the correct insertion direction into the memory card slot.

Specifications

System requirements

To use your computer with the Sound Organizer software

To use your computer with the Sound Organizer software, see “System requirements for your computer” (📖 p. 107).

To use your computer without the Sound Organizer software

To use your computer with the IC recorder without the Sound Organizer software, or to use the IC recorder as a USB mass storage device, your computer must meet the operating system requirements and port environment described below.

Operating systems

- Windows 7 Ultimate
- Windows 7 Professional
- Windows 7 Home Premium
- Windows 7 Home Basic
- Windows 7 Starter
- Windows Vista Ultimate Service Pack 2 or higher
- Windows Vista Business Service Pack 2 or higher
- Windows Vista Home Premium Service Pack 2 or higher
- Windows Vista Home Basic Service Pack 2 or higher
- Windows XP Media Center Edition 2005 Service Pack 3 or higher
- Windows XP Media Center Edition 2004 Service Pack 3 or higher*
- Windows XP Media Center Edition Service Pack 3 or higher*
- Windows XP Professional Service Pack 3 or higher
- Windows XP Home Edition Service Pack 3 or higher
- Mac OS X (v10.3.9-v10.6)

Pre-installed.

*Excluding China

Notes

- One of the above operating systems should be by default pre-installed. Any operating system other than those indicated above (Windows 98, Windows 2000 or Linux, etc.), upgraded operating systems or multi-boot environment are not supported.
- 64 bit versions of Windows XP are not supported.
- For the latest version information and compatibility with your operating system, please access the support home page for the IC recorder (📖 p. 121).

Hardware environment:

- Sound board: Sound boards compatible with any of the supported operating systems
- Port: USB port
- Disk drive

A CD-ROM drive is required. To create a music CD, you need a CD-R/RW drive.

Notes

The following systems are not supported:

- Operating systems other than the ones indicated on page 115
- Personally constructed computers or operating systems
- Upgraded operating systems
- Multi-boot environment
- Multi-monitor environment

Design and specifications







IC Recorder section	
Capacity (User available capacity)	
ICD-UX522/UX522F	2 GB (approx. 1.80 GB = 1,932,735,283 Byte)
ICD-UX523/UX523F	4 GB (approx. 3.60 GB = 3,865,470,566 Byte)
	A part of the memory capacity is used as a management area.
Maximum number of folders (for a drive)	
400 folders	
Maximum number of files (for a folder)	
199 files	
Maximum number of files (for a drive)	
4,074 files (When 21 folders are contained in a drive.)	
Frequency range	
LPCM 44.1kHz/16bit	50 Hz - 20,000 Hz
MP3 192kbps	50 Hz - 20,000 Hz
MP3 128kbps	50 Hz - 16,000 Hz
MP3 160kbps(MONO)	50 Hz - 20,000 Hz
MP3 48kbps(MONO)	50 Hz - 14,000 Hz
MP3 8kbps(MONO)	60 Hz - 3,400 Hz
Compatible file formats	
MP3* ¹	Bit rate: 32 kbps - 320 kbps (Supports variable bit rate (VBR)) Sampling frequencies: 16/22.05/24/32/44.1/48 kHz File extension: .mp3 ^{*1} The playback of MP3 files recorded using the IC recorder is also supported. Not all encoders are supported.
WMA* ²	Bit rate: 32 kbps - 192 kbps, (Supports variable bit rate (VBR)) Sampling frequencies: 44.1 kHz File extension: .wma ^{*2} WMA Ver. 9 is compatible, however, MBR (Multi Bit Rate), Lossless, Professional, and Voice are not supported. Copyright-protected file cannot be played back. Not all encoders are supported.
AAC-LC* ³	Bit rate: 16 kbps - 320 kbps, (Supports variable bit rate (VBR)) Sampling frequencies: 11.025/12/16/22.05/24/32/44.1/48 kHz File extension: .m4a ^{*3} Copyright-protected file cannot be played back. Not all AAC encoders are supported.
LPCM	Sampling frequencies: 44.1 kHz Quantization bit rate: 16 bit File extension: .wav

FM radio section (for ICD-UX522F/UX523F only)	
Frequency range	
For Korea	87.5 MHz - 108.0 MHz IF 128 kHz
For other countries and regions	87.50 MHz - 108.00 MHz IF 128 kHz
Antenna	
Stereo headphones cord antenna	
General section	
Speaker	
Approx. 20 mm (13/16 in.) dia.	
Input/Output	
Microphone jack	(minijack, stereo) input for plug in power, minimum input level 0.9 mV
Headphone jack	(minijack, stereo) output for 8 ohms - 300 ohms impedance headphones
USB connector	(Type-A) High-Speed USB compatible
microSD memory card slot	
Playback speed control (DPC)	
2.00 times - 0.50 times	MP3/WMA/AAC-LC
1.00 time - 0.50 times	LPCM
Power output	
90 mW	
Power requirements	
One NH-AAA rechargeable battery (supplied)	1.2 V DC
One LR03 (size AAA) alkaline battery (not supplied)	1.5 V DC
Operating temperature	
5°C - 35°C (41 °F to 95 °F)	
Dimensions (w/h/d) (not incl. projecting parts and controls) (JEITA)*4	
Approx. 36.6 mm × 102.0 mm × 13.7 mm (1 1/2 × 4 1/8 × 9/16 inches)	
Mass (JEITA)*4	
Approx. 58 g (2 oz) including one NH-AAA rechargeable battery	
*4 Measured value by the standard of JEITA (Japan Electronics and Information Technology Industries Association)	
Supplied accessories	
See supplied Quick Start Guide	

Design and specifications are subject to change without notice.

Maximum recording time^{*5*6}

The maximum recording time of all the folders is as follows.

REC mode (Recording scene ^{*7})	Built-in memory		Memory card				
	ICD-UX522/ UX522F	ICD-UX523/ UX523F	2GB	4GB	8GB	16GB	32GB
LPCM 44.1kHz/ 16bit	3h.	6h.	3h.	6h.	12h. 5m.	24h. 15m.	48h. 40m.
MP3 192kbps ( /  /  /  / )	22h. 20m.	44h. 40m.	22h. 20m.	44h. 40m.	89h. 25m.	178h.	357h.
MP3 128kbps ()	33h. 30m.	67h. 5m.	33h. 30m.	67h. 5m.	134h.	268h.	536h.
MP3 160kbps (MONO)	26h. 45m.	53h. 40m.	26h. 45m.	53h. 40m.	107h.	214h.	429h.
MP3 48kbps (MONO)	89h. 25m.	178h.	89h. 25m.	178h.	357h.	715h.	1431h.
MP3 8kbps (MONO)	536h.	1073h.	536h.	1073h.	2147h.	4294h.	8589h.

h.: hours/m.: minutes

^{*5} When you are going to record continuously for a long time, you may have to replace the battery with new one in the midst of recording. For details on the battery life, see the table on page 120.

^{*6} The maximum recording time in the above table is for your reference only, and may differ depending on the card specifications.

^{*7} Default settings

The maximum playback time of a music file /number of files^{*8}

Bit rate	ICD-UX523/UX523F		ICD-UX522/UX522F	
	Playback time	Number of files	Playback time	Number of files
48 kbps	178h.	2670 files	89h. 25m.	1341 files
128 kbps	67h. 5m.	1006 files	33h. 30m.	502 files
256 kbps	33h. 30m.	502 files	16h. 45m.	251 files

h.: hours/m.: minutes

^{*8} In the case where MP3 files of 4 minutes each are transferred to the IC recorder.

Battery life

When using a Sony NH-AAA rechargeable battery*1

REC Mode	Recording	Playback through speaker*2	Playback using the headphones	FM recording*3
LPCM 44.1kHz/16bit	Approx. 22h.	Approx. 14h.	Approx. 34h.	—
MP3 192kbps	Approx. 24h.	Approx. 15h.	Approx. 41h.	Approx. 7h. 30m.
MP3 128kbps	Approx. 24h.	Approx. 15h.	Approx. 41h.	Approx. 7h. 30m.
MP3 160kbps (MONO)	Approx. 24h.	Approx. 15h.	Approx. 41h.	Approx. 7h. 30m.
MP3 48kbps (MONO)	Approx. 25h.	Approx. 15h.	Approx. 41h.	Approx. 7h. 30m.
MP3 8kbps (MONO)	Approx. 30h.	Approx. 15h.	Approx. 41h.	Approx. 8h.
Music file (128 kbps/44.1kHz)	—	Approx. 15h.	Approx. 41h.	—
FM reception*3	Approx. 9h.			

h.: hours/m.: minutes

When using a Sony LR03 (SG) (size AAA) alkaline battery *1

REC Mode	Recording	Playback through speaker*2	Playback using the headphones	FM recording*3
LPCM 44.1kHz/16bit	Approx. 24h.	Approx. 20h.	Approx. 49h.	—
MP3 192kbps	Approx. 29h.	Approx. 22h.	Approx. 61h.	Approx. 8h. 30m.
MP3 128kbps	Approx. 31h.	Approx. 22h.	Approx. 61h.	Approx. 8h. 30m.
MP3 160kbps (MONO)	Approx. 31h.	Approx. 22h.	Approx. 61h.	Approx. 8h. 30m.
MP3 48kbps (MONO)	Approx. 33h.	Approx. 22h.	Approx. 61h.	Approx. 8h. 30m.
MP3 8kbps (MONO)	Approx. 42h.	Approx. 22h.	Approx. 61h.	Approx. 10h.
Music file (128 kbps/44.1kHz)	—	Approx. 22h.	Approx. 61h.	—
FM reception*3	Approx. 11h.			

h.: hours/m.: minutes

*1 The battery life is measured in testing using methods proprietary to Sony. The battery life may shorten depending on how you operate the IC recorder.

*2 When playing back music through the internal speaker with the volume level set to 13

*3 for ICD-UX522F/UX523F only

Troubleshooting

Before taking the IC recorder for repair, check the following sections. Should any problem persist after you have made these checks, consult your nearest Sony dealer.

Please access the following support home page to get the support information about your IC recorder:

For customers in Europe:

<http://support.sony-europe.com/DNA>

For customers in Latin America:

<http://www.sony-latin.com/index.crp>

For customers in the U.S.A.:

<http://www.sony.com/recordersupport>

For customers in Canada:

<http://www.sony.ca/ElectronicsSupport>

<http://fr.sony.ca/ElectronicsSupport>

For customers in other countries/regions:

<http://www.sony-asia.com/support>

Note that recorded files may be deleted during service or repair work.

On the IC recorder operations

Noise

Noise is heard.

- An object, such as your finger, etc., accidentally rubbed or scratched the IC recorder during recording so that noise was recorded.
- The IC recorder was placed near an AC power source, a fluorescent lamp or a mobile phone during recording or playback.
- The plug of the connected external microphone (not supplied) is dirty.
→ Clean the plug.
- The plug of the connected headphones is dirty.
→ Clean the plug.

Power source**The IC recorder cannot be turned on. The IC recorder does not operate, even if you press any button.**

- The battery is weak.
- The battery has been inserted with incorrect polarity (☞ p. 18).
- The power of the IC recorder is off.
 - Slide and hold the HOLD•POWER switch in the direction of “POWER” until the window display appears. The power is turned on (☞ p. 22).
- The HOLD function is activated.
 - Slide the HOLD•POWER switch in the center direction (☞ p. 16).

The IC recorder cannot be turned off.

- Slide and hold the HOLD•POWER switch in the direction of “POWER” until “Power Off” animation is displayed when the IC recorder is stopped. The power is turned off (☞ p. 22).

The IC recorder is powered off automatically.

- When the IC recorder is in the stop mode and you leave the IC recorder without attempting an operation for a certain length of time, the auto power off function will take effect. (The length of time before auto power off is set to “10min” when you purchase the IC recorder.) You can select the length of time before auto power off takes effect in the menu (☞ p. 91).

The battery life is short.

- The battery life on page 120 is based on playback with the volume level set to 13. The battery life may shorten depending on the operation of the IC recorder.
- Even if you do not use the IC recorder, the battery is consumed slightly. If you do not intend to use the IC recorder for an extended period of time, it is recommended that you turn the power off (☞ p. 22) or remove the battery. Moreover, if you set “Auto Power Off” to a short span in the menu (☞ p. 91), you can prevent the battery from being consumed due to forgetting to turn the IC recorder off.
- The battery indicator is displayed only for a short time, however, the rechargeable battery is not charged completely. It takes about 3 hours 30 minutes to fully charge an exhausted battery.
- The IC recorder has not been used for a certain time. Charge and discharge the rechargeable battery using the IC recorder several times.
- You are using the rechargeable battery in an environment with a temperature of under 5 °C (41 °F). Battery life becomes shorter as a result of the battery characteristics. This is not a malfunction.
- The rechargeable battery has deteriorated. Replace the old rechargeable battery with a new one.
- You are using a manganese battery for this IC recorder. You cannot use the IC recorder with a manganese battery.

Charging

You cannot charge the battery by connecting the IC recorder to your computer.

- When you connect the IC recorder to a computer which is not running, the battery will not be charged. Even if the computer is on, and the computer is in a mode of reduced operation (standby or sleep), you cannot charge the battery.
- “USB Charge” is set to “OFF” in the menu.
 - To charge the battery using your computer, set it to “ON” (☞ p. 91).
- Disconnect the IC recorder from your computer and reconnect it.

The charging indicator is not displayed or disappears in the middle of charging.

- A rechargeable battery has not been inserted, or a battery other than a rechargeable battery (alkaline battery, manganese battery, etc.) has been inserted.
- A rechargeable battery has been inserted with incorrect polarity.
- The USB connector of the IC recorder is not connected properly.
- While playing back files using the built-in speaker or listening to the FM radio (ICD-UX522F/UX523F only), you cannot charge the battery.
- The rechargeable battery has deteriorated.
 - Replace the old rechargeable battery with a new one.

“~~COLD~~” or “~~HOT~~” is flashing instead of the battery indicator.

- The environmental temperature is out of the range for charging. Charge the battery in an environment with a temperature of 5 °C - 35 °C (41 °F - 95 °F).

Operating

The IC recorder does not operate correctly.



- Take out the battery and insert it again.
- You may have formatted the memory of the IC recorder using the computer.
 - Use the IC recorder formatting function to format the memory (☞ p. 92).

The operation indicator does not light.

- “LED” is set to “OFF”
 - Display the menu and set “LED” to “ON” (☞ p. 89).

Recording

You cannot record a file.

- The remaining memory capacity is insufficient.
- You cannot record a file when you select a folder in the playback-only area (the  tab and the  tab).

Recording is interrupted.

- The VOR function is activated. When you are not using the VOR function, set “VOR” to “OFF” in the menu ( p. 38).

The VOR function does not work.

- During synchronized recording, the VOR function does not work.
- During recording an FM broadcast (ICD-UX522F/UX523F only), the VOR function does not work.

When recording from other equipment, the input level is too strong or not strong enough.



- Connect the headphone jack of other equipment to the  (microphone) jack of the IC recorder and adjust the volume level on the piece of equipment connected to the IC recorder.

Playback

The playback volume is low.

- The built-in speaker is mainly for monitoring, and the playback volume is low.
→ Use the supplied headphones.

No sound comes from the speaker.

- Headphones are plugged in ( p. 51).
- “Audio Output” in the menu is set to “Headphones,” when you are listening to the radio (ICD-UX522F/UX523F only).
→ Set “Audio Output” to “Speaker” ( p. 77).

Sound comes from the speaker even when the headphones are plugged in.

- If you plug in the headphones not securely during playback, the sound may come from the speaker.
→ Unplug the headphones, and then insert them securely.
- “Audio Output” in the menu is set to “Speaker,” when you are listening to the radio (ICD-UX522F/UX523F only).
→ Set “Audio Output” to “Headphones” ( p. 77).

Sound effect does not change even when the “Effect” setting is changed.

- When you are using the built-in speaker or when you are listening to the radio (ICD-UX522F/UX523F only), the effect function is invalid.
- When the NOISE CUT switch is set to “ON,” the effect function does not work.

Playback speed is too fast or too slow.

- The DPC(SPEED CTRL) switch to “ON,” and the playback speed is adjusted with ▲ or ▼.
 - Slide the DPC(SPEED CTRL) switch to “OFF” or press ▲ or ▼ to adjust the speed in DPC again (☞ p. 46).
- You cannot play back an LPCM file at a speed exceeding 1.00 times the recorded speed. If you attempt to adjust the playback speed faster than that limit, “NO FAST” appears in the display window.

Playback sound is not good when a music file is played back.

- When you play back a music file with the NOISE CUT switch set to “ON,” playback sound may be deteriorated.
 - Set the NOISE CUT switch to “OFF.”

Editing

You cannot divide a file.

- You need a certain amount of free space in the memory to divide a file.
- 199 files have been recorded in the selected folder (☐).
 - Erase some of the files (☞ p. 57) or erase all the files after you store them on the other memory media or on your computer.
- Because of the system limitations, you may not be able to divide a file at the very beginning or at the very end of the file.
- You cannot divide files other than those recorded using the IC recorder (e.g., a file transferred from a computer).

You cannot move a file.

- You cannot move a © (Podcast) file.
- You cannot move a protected file.
- You cannot move a file to a memory card.

You cannot copy a file to another memory.

- You cannot copy a © (Podcast) file to another memory.

Clock

“--:--” is displayed.

- You have not set the clock (🔗 p. 23).

“--y--m--d” or “--:--” is displayed on the REC Date display.

- The date of recording will not be displayed if you recorded the file when the clock was not set.

Display

There are fewer menu items displayed in the menu mode.

- During playback, recording, or FM reception (ICD-UX522F/UX523F only) modes, there are menu items that are not displayed (🔗 p. 79).

The remaining time displayed in the display window is shorter than that displayed in the supplied Sound Organizer software.

- The IC recorder requires a certain amount of memory for system operation. That amount is subtracted from the remaining time, which is the reason for the difference.

Files

The “Memory Full” animation is displayed and you cannot start recording.

- The memory is full.
 - Erase some of the files (🔗 p. 57) or erase all the files after you store them on the other memory media or on your computer.

The “File Full” animation is displayed and you cannot operate the IC recorder.

- 199 files have been recorded in the selected folder (📁) or 4,074 files (when there are 21 folders) in total have been recorded. Therefore you cannot record another file, or move a file.
 - Erase some of the files (🔗 p. 57) or erase all the files after you store them on the other memory media or on your computer.

The memory card is not recognized.

- Remove a memory card and check the side of the memory card. Then insert it with correct side and direction (🔗 p. 20).
- Switch the memory media of the IC recorder to “Memory Card” (🔗 p. 29).

Computers

Menu does not reflect the change in settings.

- If the battery is removed just after the menu setting is changed, or the menu setting is changed using “IC Recorder Setting” of the Sound Organizer software with the exhausted battery inserted, the menu setting may not function.

A character in a folder or file name is displayed in unreadable characters.

- The IC recorder cannot support or display some special characters and symbols that are entered on a computer using Windows Explorer or the Macintosh Finder.

It takes a long time to copy a file.

- If the file size of a file is large, it takes a considerable time to finish copying. Wait until the copying is finished.

The IC recorder is not recognized by your computer. A folder/file cannot be transferred from your computer.

- Disconnect the IC recorder from your computer and reconnect it.
- Do not use a USB hub or USB extension cable other than supplied USB connection support cable. Connect the IC recorder directly to your computer or use the supplied USB connection support cable.
- Operation is not guaranteed if you use any system requirements other than those described on page 115.
- Depending on the USB port position, the IC recorder may not be recognized. If this happens, try another port.

The file transferred from your computer cannot be played back.

- The IC recorder can recognize up to 8 levels of folders transferred to the IC recorder.
- The file format may differ from those that can be played back using the IC recorder (LPCM(.wav)/MP3(.mp3)/WMA(.wma)/AAC-LC(.m4a)). Check the compatible file formats (🔗 p. 117).

The computer cannot start.

- If you reboot the computer with the IC recorder connected to the computer, the computer may freeze or may not start properly.
→ Disconnect the IC recorder from the computer and reboot the computer again.
-

FM radio (ICD-UX522F/UX523F only)**No sound comes from the speaker.**

- “Audio Output” in the menu is set to “Headphones,” when you are listening to the radio (ICD-UX522F/UX523F only).
→ Set “Audio Output” to “Speaker” (🔧 p. 77).

Sound comes from the speaker even when the headphones are plugged in.

- “Audio Output” in the menu is set to “Speaker,” when you are listening to the radio (ICD-UX522F/UX523F only).
→ Set “Audio Output” to “Headphones” (🔧 p. 77).

The audio is weak or has poor quality when listening to the radio.

- Move the unit away from the TV.

The picture of your TV becomes unstable.

- If you are listening to an FM program near the TV with an indoor antenna, move the IC recorder away from the TV.

You cannot receive FM radio stations, or a lot of static is heard.

- The headphones are not connected (the headphone cord is the FM antenna)
→ Connect the headphones to the 🎧 (headphone) jack and extend the headphone cord.
- “DX/LOCAL” has been set to “LOCAL.”
→ Set it to “DX” (🔧 p. 75).

You cannot preset an FM radio station.

- You have already preset 30 FM radio stations.
→ Erase unwanted preset stations (🔧 p. 74).
- “Scan Sensitivity” has been set to “Low(SCAN L).”
→ Set it to “High(SCAN H)” (🔧 p. 76).

On the Sound Organizer

Refer to the help files of the Sound Organizer software, too.

The Sound Organizer software cannot be installed.

- The free disk or memory space on the computer is too small.
 - Check the hard disk and memory space.
- You are trying to install the software into the operating system that the Sound Organizer software does not support.
 - Install the software into the supported operating system (☞ p. 107).
- In Windows XP, you have logged on using a user name belonging to a user account with limitations. Or in Windows Vista or Windows 7, you have logged on using a guest account.
 - Make sure to log on using a user name with computer administrator privileges.

The IC recorder cannot be properly connected.

- Check that the installation of the software has been successful. Also check the connection as follows:
 - When using an external USB hub, connect the IC recorder directly to the computer or use the supplied USB connection support cable.
 - Disconnect and then connect the IC recorder.
 - Connect the IC recorder to another USB port.
- Your computer may be in the system standby/hibernate mode.
 - Do not let your computer enter into the system standby/hibernate mode while being connected to the IC recorder.
- Save a backup copy of all of the data stored on the built-in memory or the memory card, and then format the built-in memory or the memory card using the formatting function in the menu (☞ p. 92).

Playback sound from the computer is low./No sound is emitted from the computer.

- No sound board is installed.
- No speaker is built-in or connected to the computer.
- The volume of the sound is turned down.
- Turn up the volume on the computer. (Refer to the instruction manual of the computer.)
- The volume of WAV files can be changed and saved using the “Increase Volume” feature of the Microsoft Sound Recorder.

Stored files cannot be played back or edited.

- You cannot play back files whose file format the Sound Organizer software does not support. Depending on the file format, you cannot use part of editorial features of the software. Refer to the help files of the Sound Organizer software.

The counter or slider moves incorrectly, or noise is heard.

- This happens when you play back files that you divided.
 - Store a file on your computer first*, and then add it to the IC recorder. (*Select the saving file format that suits the IC recorder you use.)

Operation is slow when there are many files.

- When the total number of files increases, the operation becomes slower, regardless of the length of the recording time.

Display does not work during saving, adding, or deleting of files.

- It takes a longer time to copy or delete long files.
 - Wait until the copying is finished. After completing operations, the display works normally.

The software 'hangs' when the Sound Organizer software starts up.







- Do not disconnect the connector of the IC recorder while the computer is communicating with the IC recorder. Otherwise the computer operations become unstable or the data inside the IC recorder may be damaged.
 - There may be conflict between the software and other driver or application.
-

Messages List

Follow the instructions below if a message appears in the display.

Message	Cause/Remedy
HOLD Slide HOLD Switch to Activate.	<ul style="list-style-type: none"> All the button operations are disabled because the IC recorder is in the HOLD status to prevent unintentional operations. Slide the HOLD•POWER switch towards the center to release the IC recorder from the HOLD status (☞ p. 16).
Low Battery Level	<ul style="list-style-type: none"> You cannot format the memory or erase all the files in a folder because of insufficient battery power. Charge the rechargeable battery (☞ p. 18) or replace the old rechargeable battery with a new one. Or replace the old LR03 (size AAA) alkaline battery with a new one.
Low Battery	<ul style="list-style-type: none"> The battery is exhausted. Charge the rechargeable battery (☞ p. 18) or replace the old rechargeable battery with a new one. Or replace the old LR03 (size AAA) alkaline battery with a new one.
Memory Card Error	<ul style="list-style-type: none"> An error occurred while a memory card was being inserted into the memory card slot. Remove and try inserting it again. If this message persists, use a new memory card.
Memory Card Not Supported	<ul style="list-style-type: none"> A memory card that the IC recorder does not support is inserted. See “About compatible memory cards” (☞ p. 21).
Read Only Memory Card	<ul style="list-style-type: none"> A read-only memory card is inserted. A read-only memory card cannot be used with the IC recorder.
Memory Full	<ul style="list-style-type: none"> The remaining memory capacity of the IC recorder is insufficient. Erase some files before recording.
File Full	<ul style="list-style-type: none"> When there are already the maximum number of files in the selected folder or the total number of files stored on the IC recorder has exceeded the maximum, you cannot record a new file. Erase some files before recording.
Settings are Full	<ul style="list-style-type: none"> When 30 FM stations have already been stored in the IC recorder’s memory, you cannot preset a new FM station (for ICD-UX522F /UX523F only). When you rename a folder, there are already 10 folders with the same folder name as the folder you selected. Please select a different folder name from the templates.
Track Marks are Full	<ul style="list-style-type: none"> You can set up to 98 track marks for a file. Cancel unwanted track marks (☞ p. 62).
File Damaged	<ul style="list-style-type: none"> You cannot play back or edit files, because the data of the selected file is damaged.

Message	Cause/Remedy
Format Error	<ul style="list-style-type: none"> The IC recorder cannot be turned on using the computer because there is no copy of the control file required for operation. Format the IC recorder using the formatting function in the menu (☞ p. 92). Do not use your computer to format the IC recorder.
Process Error	<ul style="list-style-type: none"> The IC recorder failed in memory access. Remove and then re-insert the battery. Save a backup copy of your data and format the IC recorder using the menu (☞ p. 92).
Stop and Reinsert Memory Card	<ul style="list-style-type: none"> A memory card was inserted during recording or playback. Remove the memory card and insert it while the IC recorder is in the stop mode.
Set Date&Time	<ul style="list-style-type: none"> Set the clock; otherwise, you cannot set the alarm.
No File	<ul style="list-style-type: none"> The selected folder does not have any files. You cannot move a file or set the alarm, etc., because of this.
No Track Marks	<ul style="list-style-type: none"> There are no track marks when you attempt to erase a track mark or track marks, or divide a file at all the track mark positions.
No Memory Card	<ul style="list-style-type: none"> There is no memory card inserted into the memory card slot when you attempt to set the “Select Memory,” or “File Copy” menus.
File Protected	<ul style="list-style-type: none"> The selected file is protected or is a “Read only” file. You cannot erase it. Cancel the protection on the IC recorder or cancel “Read only” on your computer to edit the file using the IC recorder.
Already Set	<ul style="list-style-type: none"> You set the alarm to play back a file at a date and time previously set on another file. Change the alarm setting.
Past Date/Time	<ul style="list-style-type: none"> You set the alarm when the time has already passed. Check it and set the appropriate date and time (☞ p. 54).
Unknown Data	<ul style="list-style-type: none"> This data is not in a file format that is supported by the IC recorder. The IC recorder supports LPCM(.wav)/MP3 (.mp3)/WMA(.wma)/AAC-LC(.m4a) files. For details, see “Design and specifications” (☞ p. 117). You cannot play back copyright protected files.

Message	Cause/Remedy
Invalid Operation	<ul style="list-style-type: none"> You cannot divide or set a track mark in files in the folder in the playback-only area (the  tab and the  tab). When a memory card has a bad block on it, the card cannot be written to. Prepare a new memory card to replace the current one. The file name has reached the maximum number of characters; you cannot divide the file. Shorten the file name. The “Divide All Track Marks” function cannot be used because there is a track mark within 0.5 seconds from the dividing position. The “Divide All Track Marks” function cannot be used because there is a track mark within 0.5 seconds from the beginning of a file or the end of a file. The file length is less than 1 second; you cannot divide such a short file. The “Divide Current Position” function cannot be used at a position within 0.5 seconds from the beginning of a file or the end of a file.
New File	<ul style="list-style-type: none"> The file being recorded has reached the maximum size limit (2 GB for an LPCM file, and 1 GB for an MP3 file). The file will be divided automatically and recording will continue as a new file.
Invalid when Noise Cut is ON	<ul style="list-style-type: none"> When the NOISE CUT switch is set to “ON,” the effect function does not work. Set the NOISE CUT switch to “OFF.” ( p. 45).
Change Folder	<ul style="list-style-type: none"> If there are no files in the  or  folder, no folders are displayed in the display window. A folder containing a file will be displayed.
Cannot Divide - Exceeds Max 199 Files in Folder	<ul style="list-style-type: none"> When there are already 199 files in the selected folder or the total number of files stored on the IC recorder exceeds the maximum, you cannot divide a file. Erase some files before dividing a file.
Same File Name Exists	<ul style="list-style-type: none"> A file of the same file name already exists in the folder, so a file cannot be created or renamed.
Erased Track Marks too near Divide Point	<ul style="list-style-type: none"> When there is a track mark set within 0.5 seconds from the dividing position, the track mark is automatically erased.
No operation with Memory Card	<ul style="list-style-type: none"> You cannot set an alarm in a file stored on a memory card. Switch the memory media of the IC recorder to “Built-In Memory” ( p. 29, 30).
AVLS*	<ul style="list-style-type: none"> The volume of the playback sound exceeds the AVLS-specified level. Adjust the volume to a moderate level.
System Error	<ul style="list-style-type: none"> A system error other than the above has occurred. Remove the battery and re-insert it.

*: for the European models only

System Limitations

There are some system limitations of the IC recorder. Troubles as mentioned below are not malfunctions of the IC recorder.

Symptom	Cause/Remedy
You cannot display or play back music files in order.	<ul style="list-style-type: none"> If you have transferred music files using your computer, those files may not be transferred in order of transfer because of system limitations. If you transfer music files from your computer to the IC recorder one by one, you can display and play back the music files in transferred order.
A file is divided automatically.	<ul style="list-style-type: none"> The file being recorded has reached the maximum size limit (2 GB for an LPCM file, and 1 GB for an MP3 file). Therefore it is automatically divided.
You cannot enter lower-case characters.	<ul style="list-style-type: none"> Depending on the combination of the characters used for the folder name that was made on your computer, those characters may change to all capitals.
“□” is displayed in place of a folder name, title, artist name, or file name.	<ul style="list-style-type: none"> A character which cannot be displayed on the IC recorder has been used. Using your computer, replace it with one which can be displayed on the IC recorder.
When you set A-B repeat playback, the set positions move a little.	<ul style="list-style-type: none"> Depending on the files, the set positions may move.
The remaining recording time becomes shorter when you divide a file.	<ul style="list-style-type: none"> You need a certain amount of free space for a file management area to divide a file, therefore the remaining recording time will be shortened.

Trademarks

- Microsoft, Windows, Windows Vista and Windows Media are registered trademarks or trademarks of Microsoft Corporation in the United States and/or other countries.
- Macintosh and Mac OS are trademarks of Apple Inc., registered in the USA and other countries.
- Pentium is a registered trademark of Intel Corporation.
- MPEG Layer-3 audio coding technology and patents licensed from Fraunhofer IIS and Thomson.
- microSD and microSDHC logos are trademarks of SD-3C, LLC.



- Nuance, the Nuance logo, Dragon, Dragon NaturallySpeaking, and RealSpeak are trademarks and/or registered trademarks of Nuance Communications Inc., and/or its affiliates in the United States and/or other countries.
- US and foreign patents licensed from Dolby Laboratories.

All other trademarks and registered trademarks are trademarks or registered trademarks of their respective holders. Furthermore, “™” and “®” are not mentioned in each case in this manual.

The “Sound Organizer” uses software modules as shown below:
Windows Media Format Runtime

This product contains technology subject to certain intellectual property rights of Microsoft.

Use or distribution of this technology outside of this product is prohibited without the appropriate license(s) from Microsoft.

Listening for a Lifetime

Selecting fine audio equipment such as the unit you've just purchased is only the start of your musical enjoyment. Now it's time to consider how you can maximize the fun and excitement your equipment offers. This manufacturer, the Consumer Electronics Association (CEA)[®] and the American Speech-Language-Hearing Association (ASHA) want you to get the most out of your equipment by playing it at a safe level; a level that lets the sound come through clearly without annoying blaring or distortion and, most importantly, without damaging your sensitive hearing.

Sound can be deceiving. Over time your hearing "comfort level" adapts to higher volumes of sound. So what sounds "normal" can actually be loud and harmful to your hearing. Guard against this by setting your equipment at a safe level **BEFORE** your hearing adapts.

TO ESTABLISH A SAFE LEVEL:

- Set your volume control to the lowest level where you can hear the music comfortably and clearly. Prolonged exposure to anything over 85 decibels can cause gradual hearing loss.
- Once you have established a sound level where you can hear the audio comfortably, clearly and without distortion, set the dial and leave it there.
- See if your music player has a volume limiter that allows you to set a safe listening level by establishing a maximum volume level on your player. This is a great solution for parents to ensure their children listen at a safe level.
- Limit listening time to give your hearing "quiet breaks."

BE SURE TO OBSERVE THE FOLLOWING GUIDELINES WHEN WEARING YOUR HEADPHONES OR EARBUDS:

- Do not turn up the volume so high that you can't hear sounds around you.
- Do not use headphones or earbuds while operating a motorized vehicle; it may create a traffic hazard and is illegal in many areas.

Used wisely, your new sound equipment will provide years of fun and enjoyment. Since hearing damage from loud noise is often undetectable until it is too late, this manufacturer, CEA and ASHA recommend that you avoid prolonged exposure to excessive noise. The following list of sound levels is included for your information so that you can better protect your hearing.

DECIBEL LEVEL EXAMPLES:

- 30 Whisper
- 40 Quiet room
- 50 Moderate rainfall
- 60 Normal conversation
- 70 Busy traffic, vacuum cleaner
- 80 Alarm clock

CONSTANT EXPOSURE TO THESE NOISES CAN BE DANGEROUS:

- 90 Lawn mower, motorcycle
- 100 Chain saw
- 110 Rock concert
- 120 Jet plane takeoff
- 130 Jackhammer
- 140 Firecrackers

This information courtesy of the American Speech-Language-Hearing Association (ASHA), the national professional, scientific and credentialing association for more than 135,000 audiologists, speech-language pathologists, and speech, language and hearing scientists. For information on protection against noise-induced hearing loss, call the ASHA Action Center (800-638-8255), Monday through Friday, 8:30 a.m. to 5 p.m. To find an audiologist in your area, visit www.asha.org/findpro. Parents can find helpful information about how to protect their children's hearing and how to teach them about safe listening at www.listentoyourbuds.org, an ASHA award-winning public education campaign sponsored in part by CEA.

A safety tip from the Consumer Electronics Association, 1919 South Eads Street, Arlington, VA 22202 and the American Speech-Language-Hearing Association, 2200 Research Boulevard, Rockville, MD 20850.

Index

A

A-B repeat 50
 AAC-LC files 117
 Adjusting the volume 32, 42
 Alarm 54, 79, 86
 Alkaline battery 120
 AVLS (Automatic Volume Limiter System) 17, 79, 86

B

Battery indicator 18, 111
 Battery life 120
 Built-in memory 29, 30, 97
 Built-in microphones 31

C

Calendar 52, 80, 88
 Changing a file name 67, 79, 87
 Changing a folder name ... 66, 79, 87
 Changing the Scene Select settings 36, 79, 81
 Connecting the IC recorder to your computer 18, 96
 Copying a file to the other memory 60, 79, 87
 Copying files to your computer 101
 Copying music files to the IC recorder 102
 Cue 51

D

Displaying the current date and time 25
 Display window 10
 Dividing a file at all the track mark positions 65, 79, 88
 Dividing a file at the current position 64, 79, 87
 DPC (Digital Pitch Control) 46

E

Easy search 51, 79, 85
 Editing files 59
 Effect 47, 79, 84
 Erasing 57
 Erasing all files in a folder 58, 79, 88
 Erasing all the track marks 63, 79, 87
 Erasing a track mark 62, 79, 87
 External microphone 39

F

FM radio
 Listening to the FM radio 69, 70, 80, 93
 Presetting FM radio stations automatically 72, 80, 93
 Presetting FM radio stations manually 73
 Recording FM broadcasts 71
 Switching the FM radio output 77, 80, 94
 Switching the receiver sensitivity 75, 80, 93
 Switching the scanning sensitivity 76, 80, 94
 Folder 27, 66, 97

H

HOLD 16
 HOLD•POWER switch 16, 22

I

Index to parts and controls
 Display window 10
 Front 8
 Rear 9
 Input selection 39, 41, 79, 83
 Inserting a memory card 20

L

LPCM files 117

M

Maintenance	113
Memory card	20, 29, 30, 114
Menu	
Alarm	79, 86
Audio Output	80, 94
Auto Power Off	80, 91
Auto Preset	80, 93
AVLS	79, 86
Backlight	80, 89
Beep	80, 90
Calendar	80, 88
Change File Name	79, 87
Change Folder Name	79, 87
Date&Time	80, 90
Display	80, 88
Divide All Track Marks	79, 88
Divide Current Position	79, 87
DX/LOCAL	80, 93
Easy Search	79, 85
Effect	79, 84
Erase All	79, 88
Erase All Track Marks	79, 87
Erase Track Mark	79, 87
File Copy	79, 87
FM Radio	80, 93
Format	80, 92
Language	80, 90
LCF(Low Cut)	79, 83
LED	80, 89
Making settings	78
Menu Settings	79
Mic Sensitivity	79, 82
Move File	79, 87
Noise Cut Level	79, 84
Play Mode	79, 85
Protect	79, 87
REC Mode	79, 82
Scan Sensitivity	80, 94
Scene Edit	79, 81
Scene Select	79, 81
Select Input	79, 83
Select Memory	80, 89
SYNC REC	79, 83
System Information	80, 92
Time Display	80, 90
USB Charge	80, 91
VOR	79, 83
Messages list	131
microSD card	97
Monitoring the recording	32
Moving a file	59, 79, 87
MP3 files	117

N

Noise	113
Noise cut	45
Noise cut level	45, 79, 84

P

Pause recording	33
Playback	42
Playback modes	49, 85
Playback speed	46
Playback time	119
Podcasts	105
Precautions	113
Protecting a file	68, 79, 87

R

Rechargeable battery	18, 111, 120
Recharging the battery	18, 111
Recording	31
Recording from a telephone	39
Recording from other equipment	40
Recording level guide	32
Recording time	119
Recording with an external microphone	39
Recording with other equipment	56
Remaining recording time	44
Review	33, 51

S

Scene selection	34, 79, 81
Selecting a folder and a file	27
Selecting a tab	28
Selecting the memory	29, 30, 80, 89
Setting the clock	23, 80, 90
Setting the language	26, 80, 90
Sound Organizer	105
Specifications	115
Synchronized recording	40, 79, 83
System limitations	134
System requirements	107, 115

T

Tab view	15
Track mark	61
Troubleshooting	121

U

USB AC adaptor	111
USB Memory	104
Using the IC recorder with your computer	95

V

VOR (Voice Operated Recording)	38, 79, 83
---	------------

W

WMA files	117
-----------------	-----